

# Installing **CONVERTALIFT**<sup>®</sup> Automatic Cover Lifter with **VacuSeal**<sup>®</sup>

For Video Instruction Manual go to: [ConvertALift.com](http://ConvertALift.com)

**To install a ConvertALift and a VacuSeal System on a Hot Tub requires 3 items.**

1. ConvertaLift System
2. VacuSeal Cover
3. VacuSeal Lifter

*Disregard the manual in the VacuSeal Lifter and follow this manual.*

**If you have any questions,  
please call us at 860 469 2580**

**Hot Tub Products, LLC**

20 Commerce Drive, North Branford, CT

Email: [info@hottubproducts.com](mailto:info@hottubproducts.com)

Hot Tub Remote



Swim Spa Remote



# Table of Contents

Spas Not Suitable for Installation & Clearance Requirements .....	3
ConvertALift Parts List .....	4
VacuSeal Parts List .....	6
Pre-Installation Instructions .....	7
<b>STEP 1</b> - Turning Power Off & Positioning Cover, <b>STEP 2</b> - Installing Control Box & Power Supply .....	8
<b>STEP 3</b> - Attach All Extension Cables to Control Box, <b>STEP 4</b> - Installing Key Switch Assembly .....	9
<b>STEP 4</b> - Installing Key Switch Assembly (Continued) .....	10
<b>STEP 5</b> - Installing the Actuator Cables.....	11
<b>STEP 5</b> - Installing the Actuator Cables (Continued).....	12
<b>STEP 5</b> - Installing the Actuator Cables (Continued), <b>Step 6</b> - Installing the Mounting Bracket .....	13
<b>STEP 7</b> - Installing the Cover Plate, <b>STEP 8</b> - Installing V-Bar, <b>STEP 9</b> - Installing Swing Arm, <b>STEP 10</b> - Installing VacuSeal & ConvertALift Adjustable Brackets, <b>STEP 11</b> - Sliding Crossover Bar onto Swing Arm .....	14
<b>STEP 12</b> - Sliding Extension Tube Into Crossover Bar, <b>STEP 13</b> - Installing 2nd Crossover Bar, <b>STEP 14</b> - Installing 2nd Swing Arm, <b>STEP 15</b> - Installing Rear Support bar.....	15
<b>STEP 16</b> - Installing Lower Clamps, <b>STEP 17</b> - Installing Handle, <b>STEP 18</b> - Secure Crossover Bar .....	16
<b>STEP 19</b> - Secure Upper Clamps, <b>STEP 20</b> - Secure Crossover Bars, <b>STEP 21</b> - Installing Actuators, <b>STEP 22</b> - Securing Adjustable Brackets .....	17
<b>STEP 23</b> - Testing the System by Plugging in Power Supply, <b>STEP 24</b> - Securing Brackets, <b>STEP 25</b> - Proper Closing Instructions, <b>STEP 26</b> - Installing Plastic Caps .....	18
<b>STEP 27</b> - For Systems with Remote Control, <b>STEP 28</b> - Powering the ConvertALift, <b>STEP 26</b> - Final Test .....	19
<b>Key Switch Assembly Installation Template</b> .....	20

# Spas Not Suitable for Installation & Clearance Requirements

1. A cabinet height less than 12" between the ground and the bottom of the shell coping. See Fig A
2. Hot Tubs longer than 108" (Over 96" are special order and require approval by cover supplier)
3. Hot Tubs wider than 110"
4. Round spas, or those with a radius 17" or larger. See Fig B

**IMPORTANT:** Spas with a radius above 12" and up to 16" require ordering and installing an optional "VacuSeal Extended Bracket". It includes 2 brackets that mount to each of the Mounting Bracket and their adjoining cabinet panels.



Also be sure to leave about 9" of space for your cover to rest in the open position (See Fig C) and that there is adequate space around the perimeter of the spa to install the VacuSeal and ConvertALift equipment.

Figure A

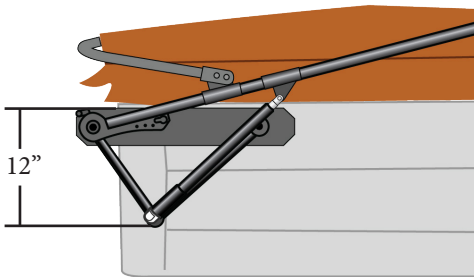

Figure B

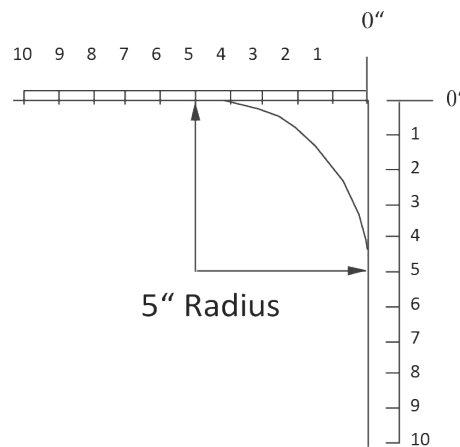
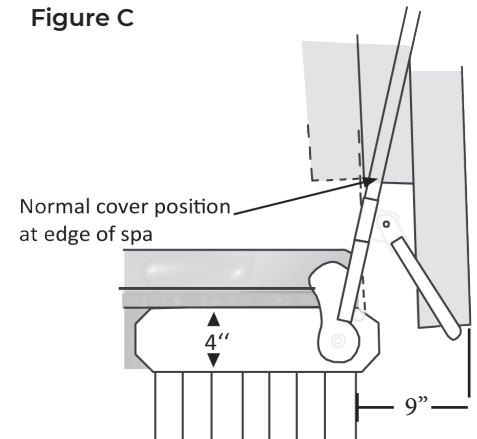

Figure C



## IMPORTANT: INSTALLING ON A SWIM SPA

Though all components are identical except the Remote Control because Swim Spa with 2 covers requires more component parts and procedural considerations.

### CONVERTALIFT CHANGES:

1. The Control Box is designed to accommodate installing four Actuators and two Key Switches on a Swim Spa instead of just two Actuators and one Key Switch on a Hot Tub.
2. The Swim Spa Remote Control allows you to open either side independently or both side in unison.

### VACUSEAL CHANGES TO FOLLOW:

1. First place both, VacuSeal Covers on the Swim Spa evenly on all sides.
2. Fully install the First VacuSeal Cover and Lifter on one side.
3. **IMPORTANT:** Then PUSH FIRMLY the Second VacuSeal Cover against the currently VacuSeal Cover and keep it in that position while installing the second VacuSeal Lifter. This will prevent a gap between the two covers helping prevent water from entering the spa along with minimizing heat loss. A major benefit to the VacuSeal System is that the cover will always return to their original installed position, eliminating repositioning.











# ConvertALift Parts List for Hot Tubs & Swim Spas

# HT - Quantity for Hot Tub # SS - Quantity for Swim Spas





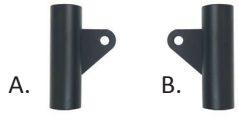







DESCRIPTION	PART #	# HT	# SS
1 Power Supply / Control Box	CLP-SCNTRL-1	1	1
2 Power Supply Cord	CLPSPLUG-US	1	1
3 Remote Control for Hot Tubs	CLP-SREMOTE-HT	1	0
4 Remote Control for Swim Spas	CLP-SREMOTE-SS	0	1
5 Electronic Linear Actuator	CLP-SACT-1	2	4
6 Key Switch Assembly	CLP-SKEYSWTCH	1	2
7 15' Actuator Extension Cable	CLP-SACTEXT-5M	2	2
30' Actuator Extension Cable	CLP-SACTEXT-10M	0	2
8 15' Key Switch Extension Cable	CLP-SKEYSWTCH	1	2
9A Slide Bracket Left	CLP104-L	1	2
9B Slide Bracket Right	CLP104R	1	2
10 V-Shaped Bracket	CLP103	2	4

## HARDWARE PACKAGE CONTENTS

DESCRIPTION	PART #	# HT	# SS
11 1/2" Hex Bolt 2"	CLP108	2	4
12 Clevis Pin	CLP111	2	4
13 2" Black Metal Washer	CLP106	2	4
14 1/2" Hex Bolt .75" Long	VS124	2	4
15 Female Spade Connectors	CLP114	3	3
16 Bushing Sleeve	CLP105	2	4
17 Cotter Pin	CLP107	2	4
18 5/8" Self Tapping Screw	VS113	8	16
19 Key Switch Screws 3/4"	CLP109	2	4
20 Ring Terminal Connector	CLP115	1	1
21 Large Plastic Caps	VS117	2	4
22 Small Plastic Caps	VS118	8	16

<p>1) Power Supply /Control Box</p> 	<p>2) Power Cord</p> 	<p>3) Hot Tub Remote</p> 	<p>4) Swim Spa Remote</p> 	<p>5) Electronic Linear Actuator</p> 
<p>6) Key Switch Assembly</p> 	<p>7) 15' or 30' Actuator Extension Cable</p> 	<p>8) 15' Key Switch Extension Cable</p> 	<p>9A &amp; 9B) Slide Brackets</p> 	<p>10) V-Shaped Bracket</p> 

## HARDWARE PACKAGE CONTENTS:

<p>11) 1/2" Hex Bolt 2" #18</p> 	<p>12) Clevis Pin</p> 	<p>13) 2" Black Metal Washer</p> 	<p>14) 1/2" Hex Bolt .75" Long</p> 
<p>15) Female Spade Connectors</p> 	<p>16) Bushing Sleeve</p> 	<p>17) Cotter Pin</p> 	<p>18) #10 5/8" Self Tapping Screw</p> 
<p>19) Key Switch Screws #4 3/4"</p> 	<p>20) Ring Terminal Connector</p> 	<p>21) Small Plastic Caps</p> 	<p>22) Large Plastic Caps</p> 

## Tools Required:

- Screw Gun
- Wrenches:
  - 1/2"
  - 7/16"
- Drill Bits:
  - 9/64"
  - 1/8"
- Hole Saws:
  - 5/8" (Optional)
  - 1 1/8"
- Tape Measure
- Phillips Screwdriver
- Template

## Recommended:

- Cable Running Rods
- Wood Clamp
- Tube Cutter
- Electrical Tape

# VacuSeal Parts List

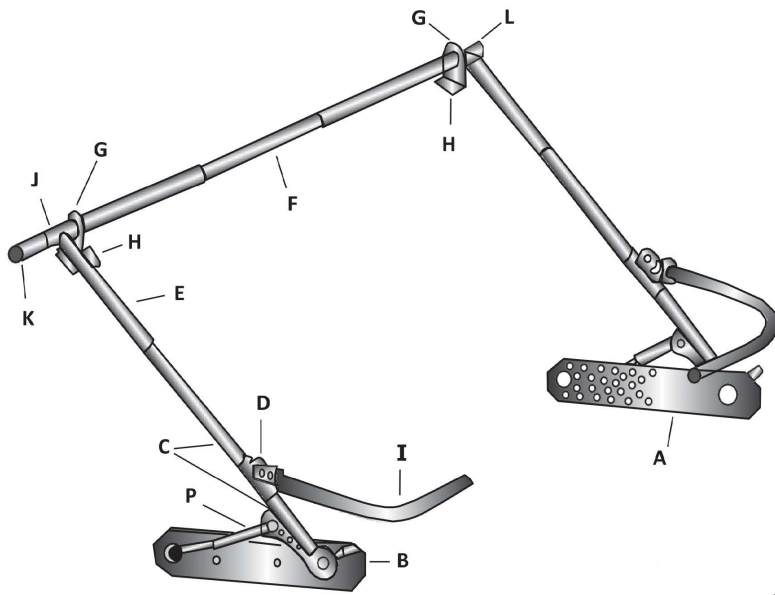























## TOOLS REQUIRED

- Screw Gun
- Wrenches:
  - 1/2"
  - 7/16"
- Drill Bits:
  - 9/64"
  - 1/8"
- Tape Measure
- Phillips Screwdriver

## Optional:

Tube Cutter may be required to cut aluminum tube on smaller spas.

<b>A) Mounting Bracket</b> PART #VS128 	<b>B) Cover Plate(2) L/R</b> PART #VS133 
<b>C) Swing Arm(2)</b> PART #VS129 	<b>D) Adjustable Bracket(2)</b> PART #VS134 
<b>E) Crossover Bar(2)</b> PART #VS130 	<b>F) Extension Tube(1)</b> PART #VS135 
<b>G) Upper Clamp(2)</b> PART #VS131 	<b>H) Lower Clamp(2)</b> PART #VS136 
<b>I) Rear Support Bar(2)</b> PART #VS132 	<b>J &amp; K) Handle Bar w/Foam Grip</b> PART #VS137, #VS110 
<b>L) Plastic Plug(3) 1-Large 2-Small</b> PART #VS119 	<b>M) Black Fender Washer(2)</b> PART #VS119 
<b>N) Lock Washer(2)</b> PART #VS125 	<b>O) Ball Studs 5/16"-18(2)</b> PART #VS116 
<b>P) Gas Springs(2)</b> PART #VS115 	<b>Q) Hex Bolts 1/4"- 20x1/2"(4)</b> PART #VS121 
<b>R) Nylon Lock Nuts 1/4" - 20(8)</b> PART #VS122 	<b>S) Hex Bolts 5/16"-18(2)</b> PART #VS124 
<b>T) Nylon Lock Nuts 5/16" - 18(2)</b> PART #VS123 	<b>U) Wood Screws #12x2(28)</b> PART #VS120 
<b>V) Self-Tapping Screws #10x5/8"(20)</b> PART #VS113 	<b>W) Machine Screws #10-32x1/2"(4)</b> PART #VS120 
<b>X) Screw Caps(30)(2-Lg 8-Med 20-Sm)</b> PART #VS111, #VS118, #VS117 	<b>Y) Rubber Safety Stop(2)</b> <b>Z) Teflon Washers(4)</b>

# Before Installing ConvertALift & VacuSeal System Together

## Pre-Installation Instructions

For the purpose of this installation, the Service Panel is the side where your spa pac is located. The opposite side we will call the Rear Panel and the others will be the Right and Left Side Panels.

**Before beginning the installation, you need to:**

1. Choose the direction of the cover.
2. Select how to power your system.
3. Decide where to install the Power Supply.

### 1. CHOOSING COVER DIRECTION

We recommend having the cover move away from the Service Panel and towards the Rear Panel.

*This eliminates having to remove mounting brackets for potential service in the future, along with allowing easy access to your control panel when the cover is open. See Fig 1*

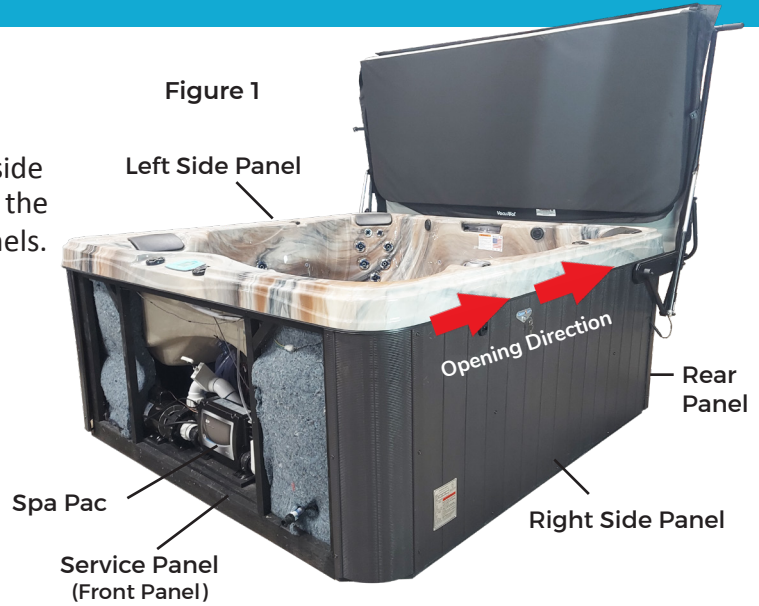

### 2. SELECTING POWER SYSTEM

There are 2 recommended ways to power the ConvertALift. For instructions on each method See **STEP 28**

#### 1. Direct to Your Spa Pack



Requires wiring your Power Supply to a 110-Volt, Non-Switched Source on your hot tub's Spa Pac.

**BENEFIT:** It eliminates having to run an external cord from your home.

**WARNING:** Must be done by a Licensed Electrician or a Certified Spa Technician.

#### 2. Dedicated 110V Line From Home

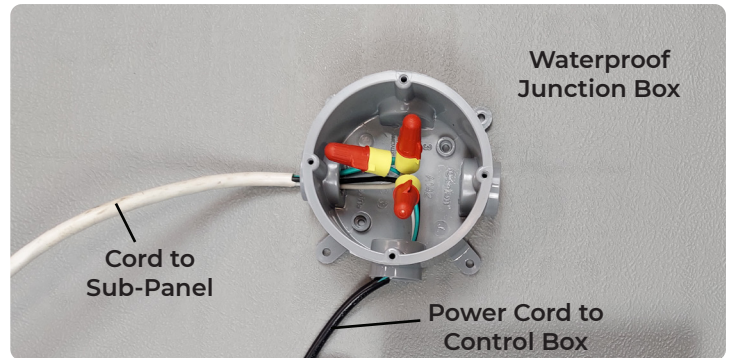

Running a Dedicated 110 Volt Line from your home's electrical panel and wiring it directly to the Power Supply using a waterproof junction box.

**BENEFIT:** It allows you to install Power Supply behind Service Panel or Rear Panel.

**WARNING:** Must be done by a Licensed Electrician in accordance with local codes.

### 3. DECIDING WHERE TO INSTALL POWER SUPPLY

#### 1. Direct to Your Spa Pack

Powering your ConvertALift "Direct to Your Spa Pac" requires you install Power Supply behind the Service Panel.

#### 2. Dedicated 110V Line From Home

Powering as a "Dedicated 110V Line" from your home allows you to choose installing the Power Supply behind the Service Panel or the Rear Panel.

# Installing ConvertALift & VacuSeal System Together

**IMPORTANT:** Before you begin the installation please read all the safety precautions provided within the ConvertALift written instruction manual.

## STEP 1 - TURNING POWER OFF & POSITIONING COVER

- 1.1 If you are installing the power supply behind the service panel, turn off the power to your hot tub and keep it off until the installation is complete.
- 1.2 Position cover squarely on the spa checking each corner. See Fig 2

Figure 2

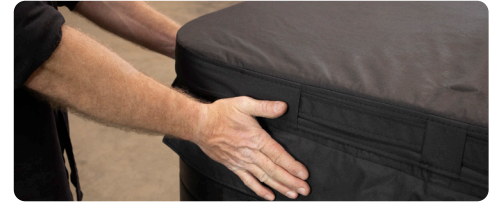

## STEP 2 - INSTALLING CONTROL BOX / POWER SUPPLY

- 2.1 Remove the cabinet panel where you have chosen to install the Power Supply. See Fig 3
- 2.2 If you plan to power the Control Box to your Spa Pac secure it within 5 feet of Spa Pac to accommodate the Power Supply Cord supplied. If possible, position Power Supply in an elevated position protecting it from any ground water that may enter into the spa cabinet. See Fig 3 & 4

Figure 3

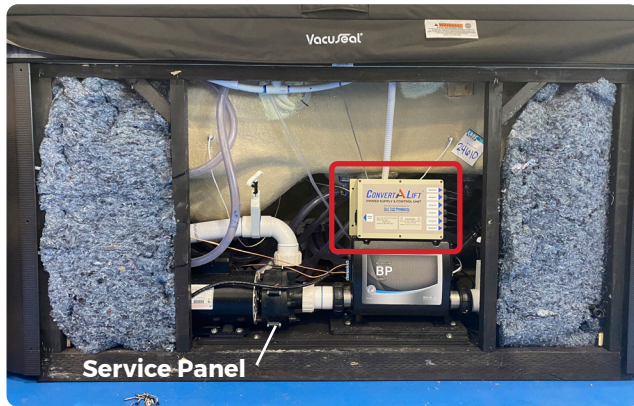

Figure 4



- 2.3 If the spa is being transported after the installation, make certain the Power Supply is properly secured preventing movement during transport.

**NOTE:** The Power Supply is adaptable for both US electrical systems that use 60 HZ along with 50 HZ electrical systems used in many countries outside the US. The only change required is ordering the proper Power Cord required for your area.

Figure 5 Power Supply / Control Box



5 1/2' Power Cord



Figure 6



**IMPORTANT:** Make certain Power Cord is plugged into Power Supply completely or malfunction may occur. See Fig 6

### STEP 3 – ATTACH ALL EXTENSION CABLES TO CONTROL BOX

**NOTE:** All Extension Cables are Directional, which means that one side is a male connection and the other a female. Plugging each one into the corresponding Pigtail on the Control Box helps prevent an error that would require you to rerun the cable. See Fig 7, 8 and 9

- 3.1 Both Actuator Extension Cables have 6-Pin Connections. Plug each of them into the 6 pin Pigtail Connectors off of the Control Box. See Fig 7
- 3.2 The Key Switch Extension Cable has a 3-Pin Connection. Plug it into the 3 pin Pigtail Connector off the Control Box. See Fig 8
- 3.3 Leave all cables accessible with the panel remaining off. See Fig 10

Figure 10

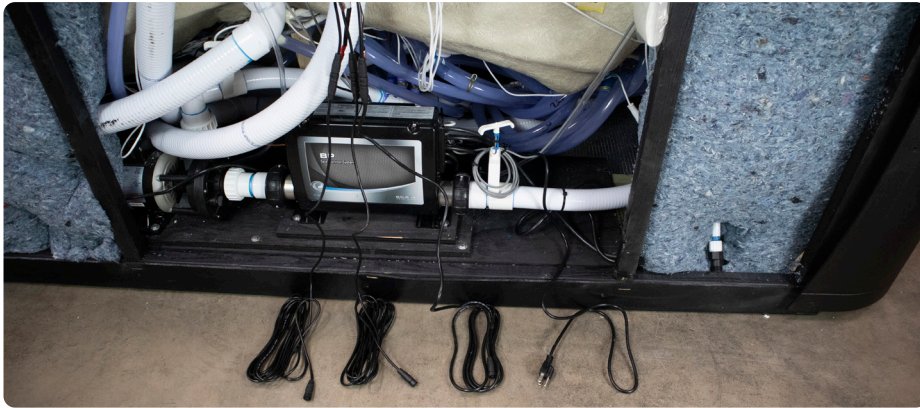

### STEP 4 - INSTALLING KEY SWITCH ASSEMBLY

- 4.1 Check that the wires and the rear Lock Nut are secure on the Key Switch Assembly. Do not remove the adhesive paper behind the plate. See Fig 11
- 4.2 Determining Key Switch Location.

**NOTE:** Key Switch should be installed on the side you would normally enter your spa that includes a Mounting Bracket. And is positioned anywhere from 60% to 80% from the end of the cabinet where the cover opens and at a height convenient for the user to operate. Installing the Key Switch requires you to drill a hole in the cabinet panel. See Fig 12

Figure 12

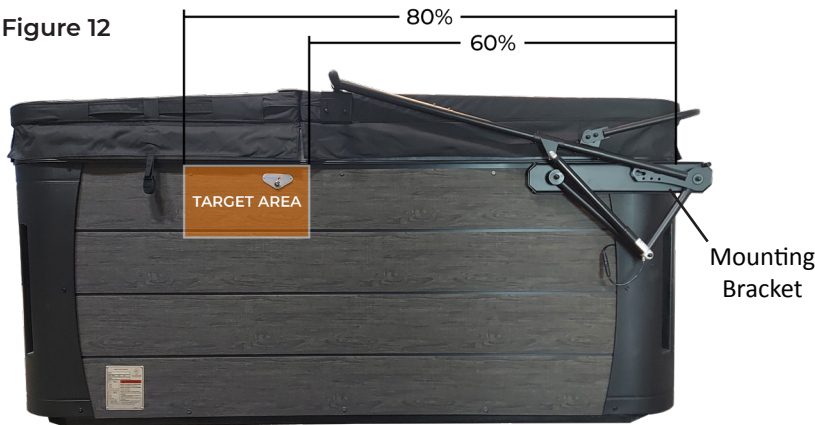

Figure 7  
Actuator Cable End



Figure 8  
Key Switch Cable End



Figure 9

- Control Box Connections:**
- A. Keyswitch 1 (Hot Tubs)
  - B. Actuator A (Hot Tubs)
  - C. Actuator B (Hot Tubs)
  - D. Actuator C (Swim Spas Only)
  - E. Actuator D (Swim Spas Only)
  - F. Keyswitch 2 (Swim Spas Only)

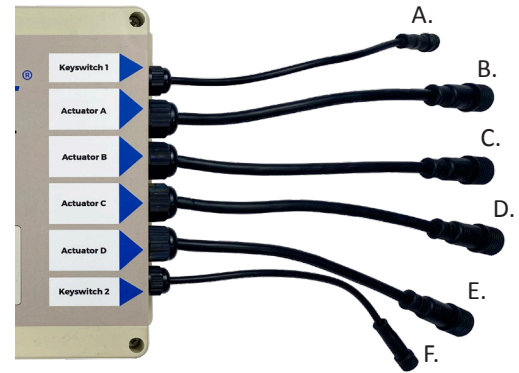

Figure 11

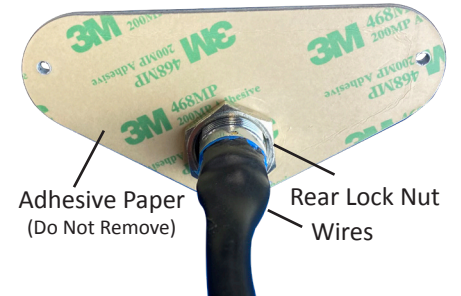
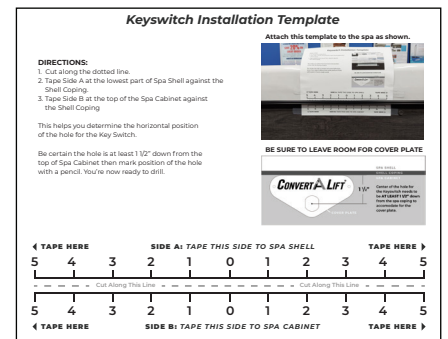

Figure 13



See detailed instructions for using the Template on the next page.

**IMPORTANT:** If you are uncertain if there is an obstruction where you are planning to drill the hole then you should remove the panel and use the Template provided. See Fig 13



## STEP 4 - INSTALLING KEY SWITCH ASSEMBLY (CONTINUED)

**USING THE TEMPLATE:** Cut along the dotted line and then tape Section A at the bottom of the shell coping and B along the top of the cabinet. (See Fig 14) Then remove the cabinet panel. This helps you determine the horizontal position of the hole. See Fig 15 Be certain the hole is at least one and a half inches from top of cabinet then mark the position of the hole. See Fig

Template Cut & Taped to Coping & Cabinet

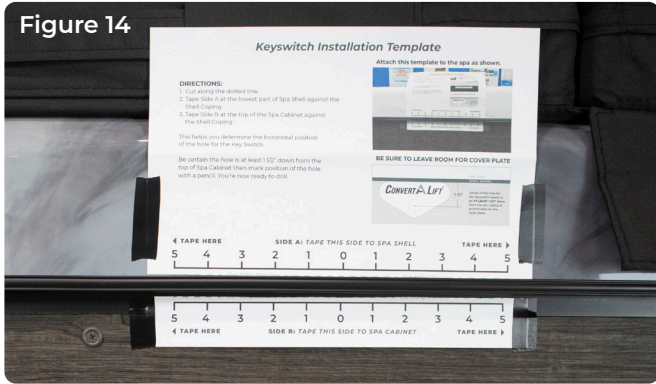

Panel Removed

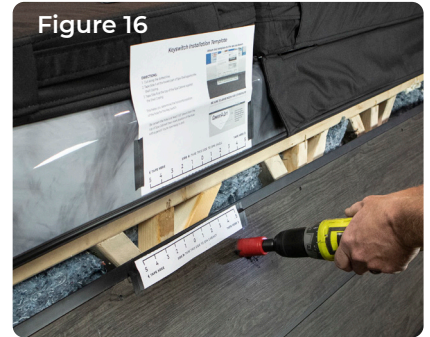
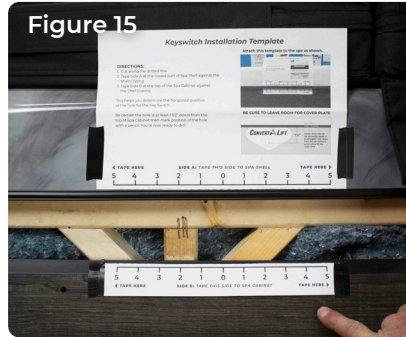
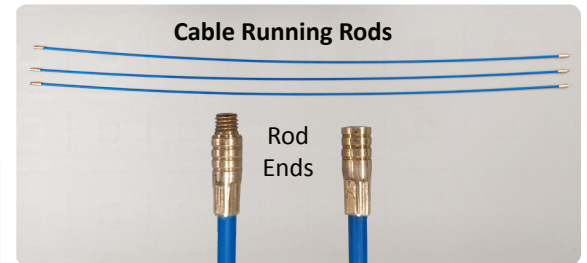

Figure 17

**4.3 Using a 1 1/8" Hole Saw drill a hole in the cabinet panel. See Fig 16**

**4.4 Position Key Switch Extension Cable in Target Area.**

**NOTE:** We recommend using Cable Running Rods. We make available a package of three, 3' Foot rods, that can be screwed together to extend up to 9 Feet. See Fig 17



### There Are Two Ways Run the Cable to the Target Area

**4.4A Feeding Key Switch Cable from Control Box**



**4.4A Feeding Key Switch Cable From Control Box**

With the Side Panel removed, you may be able to simply hand feed the cable from Control box and then grab the cable and pull it through the hole. Having a removable Corner Panel on the cabinet also makes it more possible. See Fig 18

**4.5 Connect the Key Switch Pigtail to the Extension Cable.**

Make sure the wiring is secure before placing it through the hole then secure the Key Switch Plate with one screw. Check to be certain the Plate is level and then secure with the second screw. See Fig 23



**4.4B Snaking a Cable Rod Through Hole**



**4.4B Snaking a Cable Rod Thru the Hole**

Re-attach the Side Panel with the hole already drilled, and snake a Cable Running Rod through the hole towards the control box. (See Fig 19) Securely tape the Key Switch Extension Cable to the Cable Running Rod. (See Fig 20) and then pull the Rod through the hole until you can grab onto the cable. See Fig 21

Figure 20



Figure 21

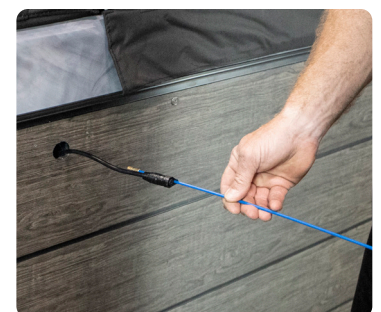

## STEP 5 - INSTALLING THE ACTUATOR CABLES

**NOTE:** Installing the Actuator Cables often (but not always) requires two steps.

1. Running the Extension Cables to the Corners of the Cabinet. See 5.1
2. Positioning the Cable Ends in the Target Area. See Step 5.2 and Fig 22

Figure 22

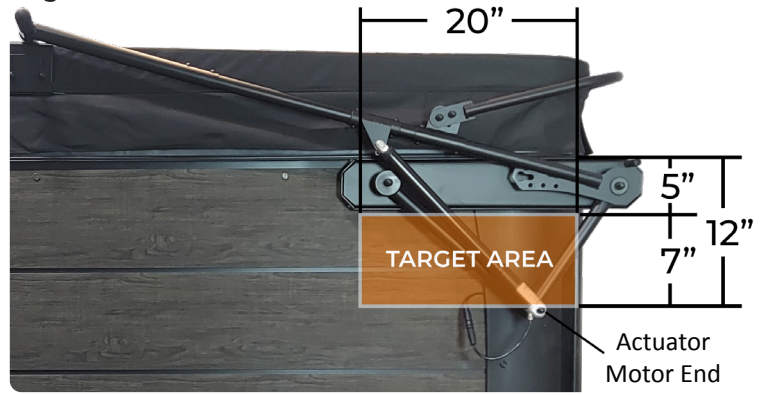

### HELPING YOU DETERMINE LOCATION OF THE POWER SUPPLY

Figures 23 & 24 demonstrate that installing the Actuator Cables is easiest when the Power Supply is on the side closest to the Mounting Brackets. **BUT NOTE:**

1. The location of the Mounting Brackets determine the side where the Cover opens to and it is preferred (not required) to have the Control Panel opposite the cover so that it is convenient to access it when the cover is closed.
2. Control Panels on most hot tubs are located on the same side as the Spa Pac. And if you are attaching the Power Supply to the Spa Pac, they must be within 5 feet each other.

Figure 23

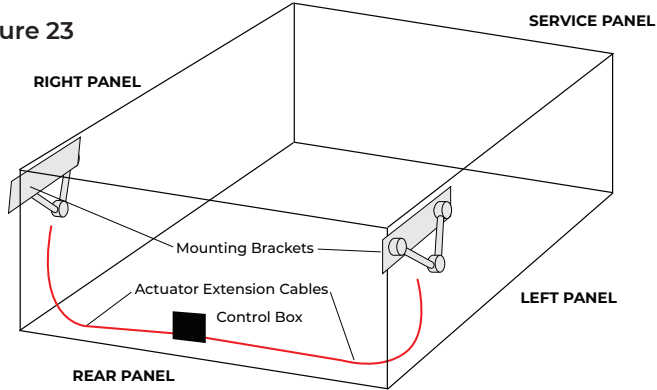
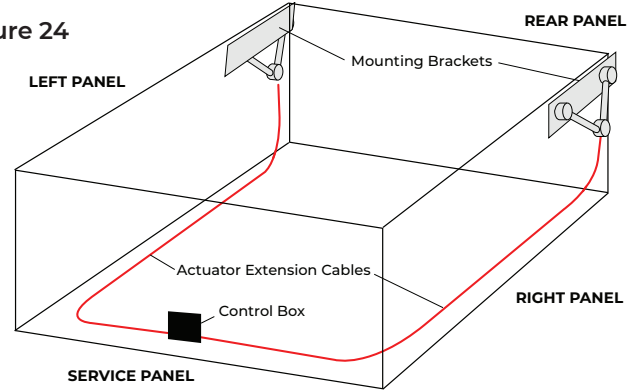

Figure 24



### 5.1 Running the Extension Cables to Corners of Cabinet

There are 3 methods to choose from to run the Cables to the Corners of the Cabinet:

#### 5.11 Snaking the Cables Through the Cabinet Interior



#### 5.12 Positioning Cables Behind Cabinet Side Panels



#### 5.13 Running Cables Along Cabinet Lower Perimeter

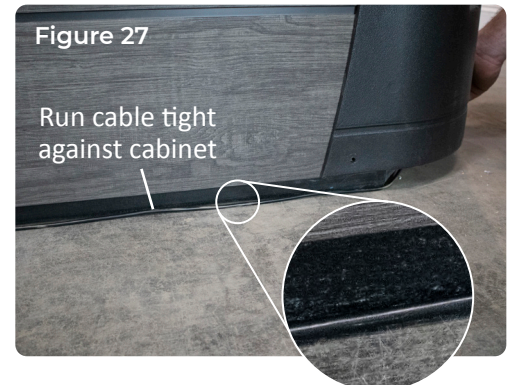

Detailed Instructions for Each of These Methods on the Next Page

**IMPORTANT:** Careful Not to Pinch Cables or to Bend Them at Less Than a 1" Radius.

## STEP 5 - INSTALLING THE ACTUATOR CABLES (CONTINUED)

### 5.11 Snaking the Cables Through the Cabinet Interior (Continued)

Remove the Corner Panels where the Mounting Brackets are to be installed. If they are not removable, remove the Rear Panel. Then feed a Cable Running Rod (or something similar) from that panel, through the interior of the cabinet, towards the Control Box where the Actuator extension cables are located. See Fig 28

Make sure to leave enough of the Cable Rod to grab onto. See Fig 29

Go to the Control Box, capture the Cable Rod and securely tape it to the Actuator Ext Cable. See Fig 30

Then go back to Corner Panel, grab hold of Cable Rod and pull it through the spa's interior until you can capture the taped end of the extension cable. See Fig 31

**NOTE:** This procedure can also be done with a broom handle just not as easily.

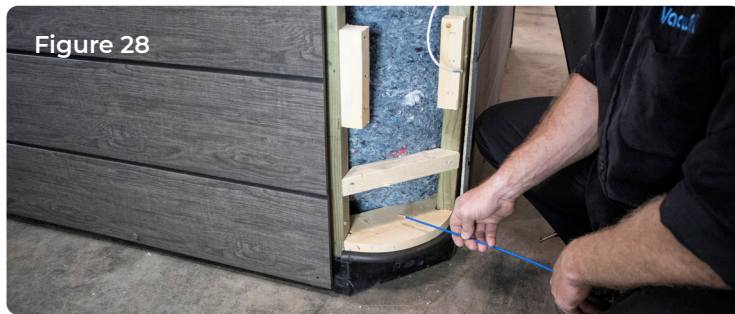

### 5.12 Running the Cables Behind the Side Panels

Remove the Side Panels and position the Actuator Extension Cable behind the Panels. If the interior of the spa is fully foamed the Extension Cables are thin enough to go between the panels and the insulation. If necessary, position cables behind any framing material. See Fig 32

Figure 32

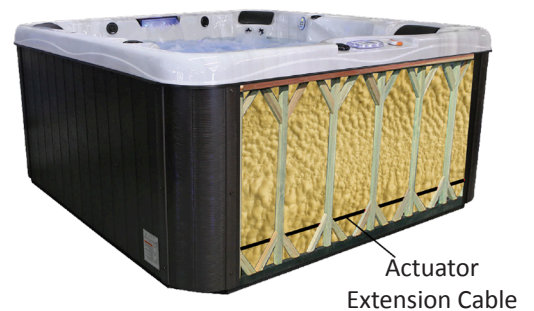

### 5.13 Running Cables Along Cabinet Lower Perimeter

The easiest method of running the Actuator Extension Cable is positioning them along the lower perimeter of the cabinet. (See Fig 33). If you choose this method then it is strongly recommended to secure the cable somehow, either with a cover board or removing the screws on the bottom of cabinet and securing them inside along the bottom of the cabinet. Left unsecured, the cable will become loose and open for damage. See Fig 34

Figure 33



Figure 34



**REPEAT YOUR CHOSEN METHOD  
ON THE OTHER SIDE(5.11, 5.12 or 5.13)**

## STEP 5 - INSTALLING THE ACTUATOR CABLES (CONTINUED)

### 5.2 Positioning Cable Ends in the Target Area

There are 3 methods to choose to position Cable Ends in Target Area

#### 5.2.1 Behind the Corner Panel



*Most Preferred Method*

**5.2.1** Remove the Corner Panel where the Mounting Bracket would be installed. Then Slide the Cable to a point where it is within the Recommended Target Area. Then reinstall the Corner Panel to secure the Cable. See Fig 35

#### 5.2.2 Through a Hole in the Cabinet

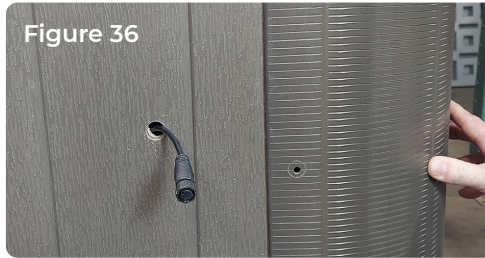

**5.2.2** Drill a 5/8" Hole Saw drill a hole in the Target Area. See Fig 36

**Note:** Be sure there is no obstruction behind the cabinet panel and feed the Extension Cable through it. This may require removing the Side Panel.

#### 5.2.3 Installing Cable within U Channel

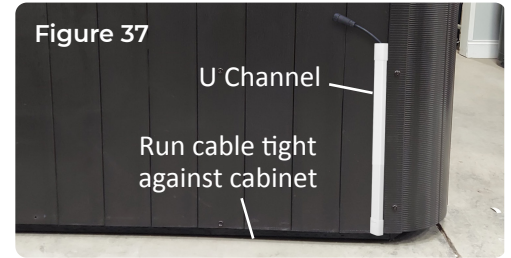

**5.2.3** Installing Cable within a 5/8" or larger U Channel on the cabinet. Install the U Channel from the bottom of the cabinet to the point in the Target Area. See Fig 37

**Note:** This is not the most attractive method but ideal for customers with cabinets that have no Removable Corner Panel or for those not wanting to drill a hole in their cabinet.

## STEP 6 - INSTALLING THE MOUNTING BRACKET

**REMINDER** If the Radius of your cover is greater than 12" and less than 16" you need to use our optional "Extended Bracket". To install the Mounting Bracket requires attaching the an Extended Bracket to each of the Mounting Brackets. Once attached simply position them squarely on each corner and use that position to secure each Mounting Bracket. More detailed instructions are within the package. If your Radius is greater than 16" then our product will not properly attach to your spa. See Fig 36

OPTIONAL EXTENDED BRACKET FOR LARGE RADIUS SPAS



**NOTE:** Mounting Brackets are to be installed on each Side Panel and to the rear of the spa, where the cover is intended to be positioned when open.

- 6.1** Measure 22" back from the furthest point on the spa cabinet and mark with a pencil. See Fig 37
- 6.2** If unknown to you, check to see if there is a solid structure to screw into. If necessary, install supports to the spa frame, usually short 2x4 material works fine.
- 6.3** Position the Mounting Bracket at your pencil line, flush under the spa coping. Make sure the safety stop is at the top and rear of the spa. Fig 38
- 6.4** The mounting bracket must sit flush on the cabinet. If it doesn't, remove any protruding screws and add a wood spacer to level the area off. Fig 39
- 6.5** Hold bracket in position and pre-drill two holes with a 3/4" drill bit to prevent splitting wood. See Fig 40
- 6.6** Secure the 2 holes with Wood Screws. Secure the Mounting Bracket with a minimum of 8 Wood Screws, though more is always better. Fig 42

Figure 37



Figure 38



Figure 39

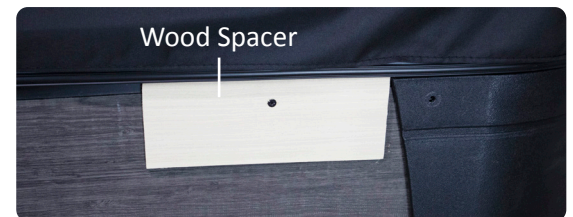

**NOTE:** On spas with STEEL FRAMES use a Metal Bit to Pre-drill all holes and then securing with Wood Screws will work just fine.

Figure 40



Figure 41



Figure 42



## STEP 7 - INSTALLING THE COVER PLATE

- 7.1 Position Cover Plate over Mounting Bracket and secure with 2 machine screws using a hand-held Phillips Screwdriver. See Fig 43

Figure 43



## STEP 8 - INSTALLING THE V-BAR

- 8.1 Slide the V-Bar over the 2 Bosses on the Mounting Bracket with the short side closest to the rear of the spa. See Fig 44
- 8.2 Place a 2" Black Metal Washer on the Mounting Bracket Boss furthest from the rear of spa and attach with a Short 1/2" Hex Bolt. Fig 45 & 46

Figure 44

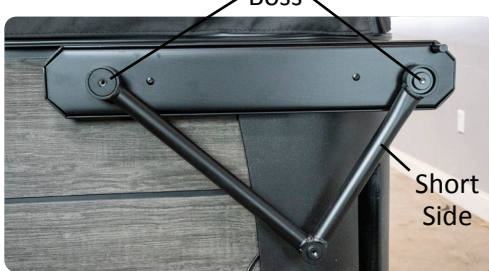

Figure 45



Figure 46



REPEAT STEPS 6 – 8 ON THE OTHER SIDE

## STEP 9 - INSTALLING THE SWING ARM

- 9.1 In your hand hold a Short 1/2" Hex Bolt and place a locking washer over it, then add a Black Machined Washer, followed by a Teflon washer. See Fig 47
- 9.2 Then place a separate Teflon washer over the Boss closest to the end of the spa. See Fig 48
- 9.3 With the other hand position the swing arm on the Boss with the flat extended plate pointing down. Rest Swing Arm down. See Fig 49
- 9.4 Install Hex Bolt assembly in your hand, keeping washers even, then firmly tighten with a 1/2" wrench until lock washer is compressed.

Figure 47

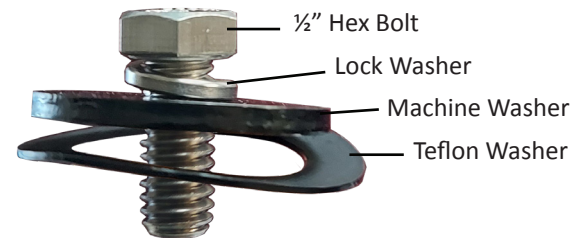

Figure 48



## STEP 10 - INSTALLING VACUSEAL AND CONVERTALIFT ADJUSTABLE BRACKETS

- 10.1 Raise the Swing Arm and then slide a VacuSeal Adjustable Bracket over it with the flat extension towards the rear of the spa and the "smiley faced" hole at the bottom. See Fig 49
- 10.2 Then slide the ConvertALift Adjustable Bracket on the Swing Arm with the flat triangular plate positioned furthest from the spa and the short side toward the rear of spa. See Fig 49

Figure 49

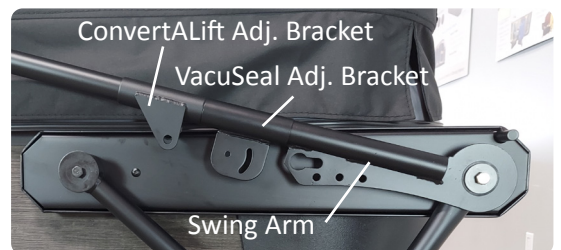

LEAVE BOTH BRACKETS UNSECURED

## STEP 11 - SLIDING CROSSOVER BAR ONTO SWING ARM

- 11.1 Slide the longer side of a "Crossover Bar" through the Upper Clamp and the shorter side over the Swing Arm. Then lay the longer side of the Crossover Bar on the cover. See Fig 50
- 11.2 Position Upper Clamp over the slit in the cover flap and leave Crossover Bar unsecured. See Fig 51

Figure 51



Figure 50

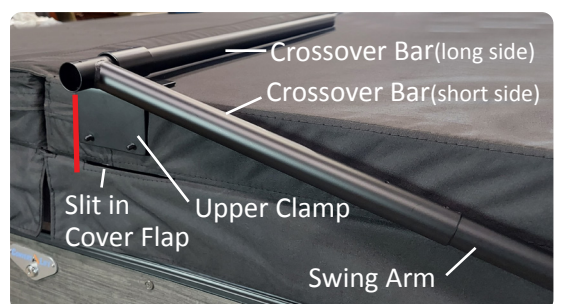

**IMPORTANT:** If cover is less than 78" long you will have to cut both Swing Arms with a tube cutter for the Upper Clamp to sit over the cover slit. If you cut the Swing Arms be sure it remains visible through the pre-drilled holes in the Crossover Bar.

## STEP 12 - SLIDING EXTENSION TUBE INTO CROSSOVER BAR

- 12.1 The Extension Tube is 40" long. Put a pencil mark at the 20" center point which will assist you later in the installation. See Fig 53
- 12.2 Slide Extension Tube partially into the Crossover Bar and leave it unsecured. See Fig 52

## STEP 13 - INSTALLING SECOND CROSSOVER BAR (SAME AS OTHER SIDE)

- 13.1 Slide the longer side of the second "Crossover Bar" through the second "Upper Clamp" and then onto the Extension Tube. Make certain to keep center point of Extension Tube visible. See Fig 53
- 13.2 Just as was done on the first side, position Upper Clamp over the slit in the Cover.
- 13.3 Check that the pencil mark on the extension tube is centered. See Fig 53

### LEAVE ALL PARTS UNSECURED

**NOTE:** If cover width is less than 66" you will need to cut both sides of the Crossover Bars. Ideally cut both of them equally to provide symmetrical appearance.

## STEP 14, INSTALLING SECOND SWING ARM (SAME AS OTHER SIDE)

- 14.1 Place a Teflon washer over the Boss.
- 14.2 Slide both the VacuSeal and ConvertALift Adjustable Brackets on the Swing Arm just as was done on the other side.
- 14.3 Then Slide both the VacuSeal and ConvertALift Brackets on the Swing Arm. Then slide it into the Crossover bar and just like on the other side, do not secure it. Then position it on the boss and secure with the same hardware as before.

## STEP 15, INSTALLING REAR SUPPORT BAR

- 15.1 Insert long side of Rear Support Bar into the back sleeve of the cover so that it is parallel and flat against the cover. See Fig 54
- 15.2 Position the other side of the Rear Support Bar against outer side of the VSL Adjustable Bracket and align the two holes and insert Hex Bolt into first hole. See Fig 55
- 15.3 Secure the first hole with a Hex Bolt and Nylon Lock Nut with a  $\frac{7}{16}$ " wrench. See Fig 56
- 15.4 Check that the long side is still sitting flat against cover and the short side is parallel with the Swing Arm. (See Correct Fig 57 , and Incorrect Fig 58) and then secure the second hole identically as the first hole.

### REPEAT ON THE OTHER SIDE

Figure 52

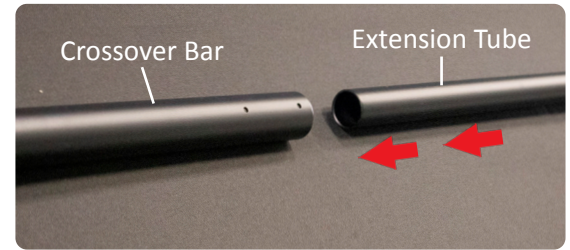

Figure 53

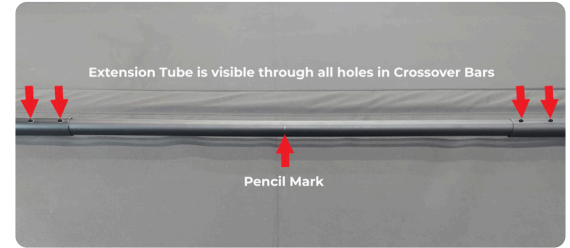

Figure 54



Figure 55



Figure 56



Figure 57 Correct: Rear Support Bar is Straight & Aligned with Cover



Figure 58 Incorrect: Rear Support Bar is Not Aligned with Cover



## STEP 16 - INSTALLING LOWER CLAMPS

- 16.1 Make certain the Upper Clamp is over the Cover Slit as close to cover fold as possible. (See Fig 59) Then lift the cover slightly and slide the rubber pad into the cover slit putting it also as close to the cover fold as possible. See Fig 60
- 16.2 Then loosely install both Nylon Lock Nuts.
- 16.3 Squeeze clamps together using a wood clamp then very securely tighten Lock Nuts with a 7/16" wrench. See Fig 61

**NOTE:** Hand squeezing the clamps without a wood clamp can work, but it doesn't guarantee the cover will not move at a later date.

REPEAT THIS ON THE OTHER SIDE

## STEP 17 - INSTALLING THE HANDLE

- 17.1 Slide Handle fully into the Crossover Bar that is on the same side as the Key Switch and leave unsecured. See Fig 62

**NOTE:** Handle will act as a convenient robe holder, also for use in emergency situations.

## STEP 18 - SECURE CROSSOVER BARS TO SWING ARMS

- 18.1 **IMPORTANT**, check that the Cover sits evenly on all sides and on each corner. See Fig 2
- 18.2 Measure the distance "X" from "Open End of Swing Arm" to its "Connection Point" on Crossover Bar. (See Fig 66) Make certain the distance on both sides is exactly the same. Shift the cover if necessary.
- 18.3 Make certain both sides are running parallel and that there is clear, even space between Swing Arm and the cover so that it will open without any obstruction. See Fig 65
- 18.4 Pre-drill holes in the Crossover Bar with a 5/32" drill bit then secure it to the Swing Arm with self-tapping screws. See Fig 63 & 64

REPEAT ON THE OTHER SIDE

Figure 65



Figure 59



Figure 60



Figure 61



Figure 62



Figure 63

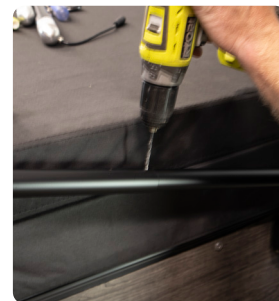

Figure 64

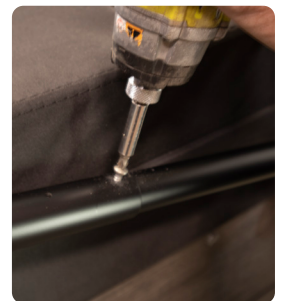
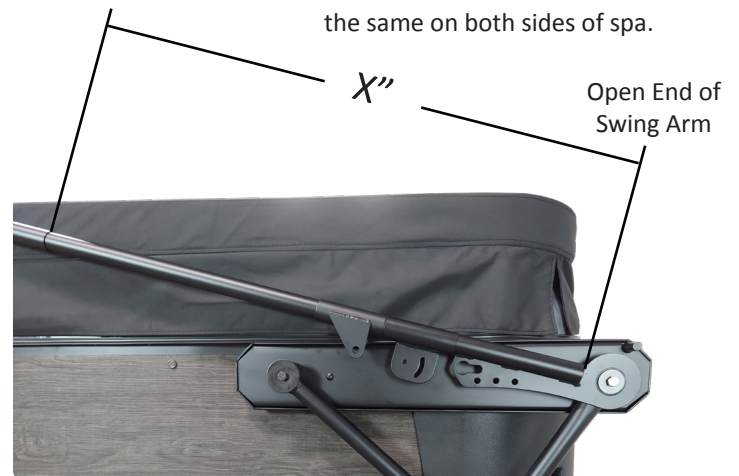

Figure 66

Connection Point

**IMPORTANT:** Measurement "X" needs to be the same on both sides of spa.



## STEP 19 - SECURE UPPER CLAMPS TO CROSSOVER BAR

- 19.1 On the side with the handle pre-drill holes with a 5/32" drill bit into the Crossover Bar and the handle and then secure with self-taping screws. See Fig 67 & 68

REPEAT ON THE OTHER SIDE WITHOUT HANDLE

## STEP 20 - SECURE CROSSOVER BARS TO EXTENSION TUBE

**WARNING:** Make certain to use a hard, protective material to protect potential damage to the cover before securing Crossover Bar to Extension Tube. **Damage is not covered under warranty.** See Fig 69

- 20.1 Check that Extension Tube is visible, then pre-drill holes using a 5/32" drill bit.  
20.2 Secure with Self-Tapping Screws. See Fig 69

## STEP 21 - INSTALLING LINEAR ACTUATORS

- 21.1 Slide a Bushing Sleeve onto the Long 1/2" Hex Bolt and then slide the bolt into the bottom hole of the Actuator with cable pointing down. See Fig 70 & 71  
21.2 Position Actuator over the bottom of the V-Bar and secure it tightly using a 1/2" wrench.  
21.3 Position the other side of the Actuator over the Adjustable Bracket plate, line up the holes, and slide in the Clevis Pin. See Fig 72,73 & 74  
21.4 Secure Clevis Pin with the Retainer Clip into the first notch.  
21.5 Attach Actuator Extension Cable to Pigtail Cord on the Actuator and leave a short bottom loop to prevent rainwater from running directly to Actuator Motor end. See Fig 75

Figure 67



Figure 68

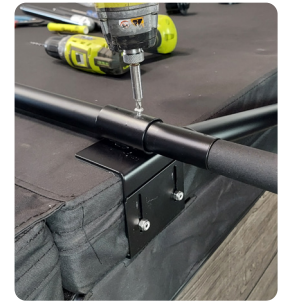

Figure 69



Figure 70



Figure 71

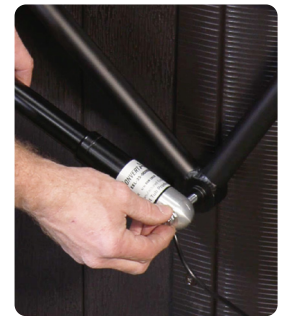

Figure 72



Figure 73



Figure 74



Figure 75

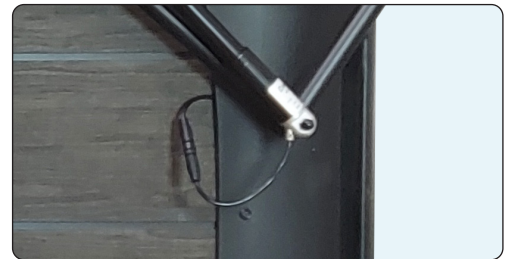

## STEP 22 - SECURING ADJUSTABLE BRACKETS TO THE SWING ARMS

- 22.1 Secure the ConvertALift Adjustable Bracket to the Swing Arm by installing self-tapping screws into the two top holes. The bottom holes will be secured later. See Fig 76  
22.2 Secure the VacuSeal Adjustable Bracket with a self-tapping screw into the one accessible hole. The non-accessible top hole will not require a screw and the bottom holes will be secured later. See Fig 77

REPEAT STEP 21 & 22 ON THE OTHER SIDE

Figure 76

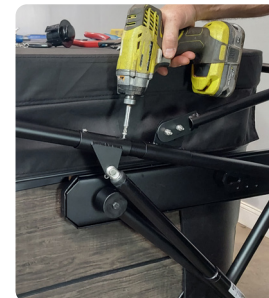
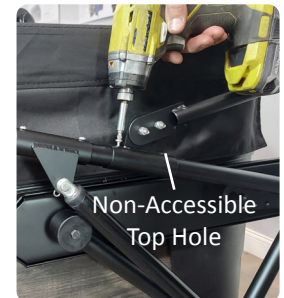

Figure 77





## STEP 23 - TESTING THE CONVERTALIFT SYSTEM BY PLUGGING IN THE POWER SUPPLY

**23.1** Attach the plug from the Power Cord to any approved outdoor extension cord and plug that cord into any GFCI protected outlet. Fig 78

**WARNING:** This is not a recommended installation, but it's ideal for testing your system prior to it being permanently wired.

**WARNING:** Make certain NO COVER STRAPS ARE ATTACHED TO THE HOT TUB CABINET. If any are attached, it can cause DAMAGE to the hot tub or the cover and neither are covered under the warranty. See Fig 79

**23.2** Once the power supply is plugged-in, turn the Key Switch (try both directions) to raise the cover. If it raises the cover then move on to the next step. Do not close the cover, leave it in the open position.

If turning the Key Switch in either direction does not raise the cover check the following:

1. Check that the outlet you are utilizing at your home is active. The breaker may have tripped.
2. Check that the Power Cord is firmly connected to the Control Box and that all Cable connections are secure.
3. Go to "Step 27 ACTIVATING YOUR REMOTE" and test opening the cover on your remote.

If none of these actions caused the failure of the cover to open visit the "ConvertALift Trouble Shooting Guide". If you are unable to activate the ConvertALift call your dealer for support.

To Test Your System press any key on your Remote twice about a half a second apart. Do not press quickly as if it was a mouse on a computer. The cover should automatically open. The Remote should be affective up to 150' away. Allowing you to open your cover from in your home.

## STEP 24 - SECURING THE BOTTOM HOLES ON THE ADJUSTABLE BRACKETS

**24.1** With the cover up, use self-tapping screws to secure all lower holes in the bottom of the VacuSeal and the ConvertALift Adjustable Brackets. Fig 81

REPEAT ON THE OTHER SIDE

## STEP 25 - HOW TO PROPERLY CLOSE THE VACUSEAL COVER

The preferred and recommended way to close the cover is with the Key Switch. A VacuSeal Cover that has a bottom hinge(See Fig 82) that requires you to guide it down whether it is used with a ConvertALift system or with just a VacuSeal Lifter with gas shocks.

### CLOSING WITH A CONVERTALIFT

1. Turn the Key Switch and wait about 3 seconds and then guide the cover down so that it does not get stuck on the top of the spa. You may need to continue to guide it if your spa has raised pillows or controls. See Fig 84
2. Make sure the Rain Flap is above the fold.
3. When the cover is fully closed or just before it closes raise the short side of the

Figure 78



Figure 79



Figure 80



Figure 81

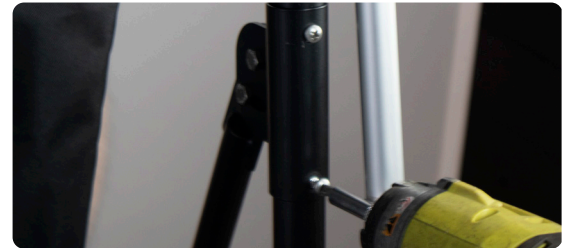

Figure 82

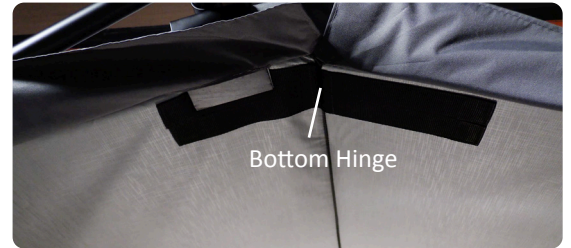

Figure 83



Figure 84



## WHY NOT TO USE THE REMOTE TO CLOSE COVER

It is not recommended to use the Key Fob for closing the cover, it should only be used as a back-up if needed. Holding the button down requires a constant signal to be sent to the Control Box which can easily be disturbed, which causes the stuttering motion. The other downside is that it also drains the battery within the Key Fob.

Keeping the Key Fob in a drawer or on a shelf, close to the exit door allows you to remotely open the cover from in your home along with knowing where the Key Fob is the next time you use the hot tub. It also eliminates having it get lost in the pocket of your robe or worse, falling into the water when you rest in on the top of your spa.

You will find that using the Key Switch to close the cover when you exit your spa is the most convenient and preferred method.

## STEP 26 - INSTALLING PLASTIC CAPS AND PLUGS

To give your spa a finished look, install small caps on all self-tapping screws, medium caps on mid-sized bolts, and Large caps on large bolts. (See Fig 85, 86 & 87) Plus be sure to put rubber sleeve on safety stop, medium sized plugs on open ends of Rear Support bar and a large plug on the side of the crossover bar that does not have a handle.

## STEP 27 - ACTIVATING THE REMOTE CONTROL

1. Unplug the Power Cord to the Control Box turning off your system
2. Wait 10 Seconds and plug the Power Cord back into your Control Box
3. Within the next 15 seconds press any key on your Remote and hold it for about 5 seconds.
4. Press the button on the Remote twice within ½ a second apart.
5. To Program your Remote Control first unplug the Power Cord and wait about 10 seconds. Then plug the Power Cord back into the Control Box and within 15 seconds press any key on your Remote and hold it for about 5 seconds (Do not press quickly as if it was a mouse on a computer). The cover should automatically open. The Remote should be affective up to 150' away. Allowing you to open your cover from in your home.
6. If the Remote does not work, make certain that the light on the Remote turns on when you press it. If the Remote light does not go on, then your battery needs replacing. The battery required for the Remote uses a 12V 27A.

**WARNING:** If you are not permanently powering up your spa at this time make certain to close any open hot tub cabinet panels.

## STEP 28 - POWERING THE CONVERTALIFT SYSTEM

There are 2 ways to Power the ConvertALift, Direct to the Spa or with a Dedicated 110V Line from home.

### 25.1 DIRECT WIRE TO THE SPA PAC

Cut the end off of the Power Cord, strip the wires (See Fig 88), attach the Female Spade Connectors (See Fig 89), and attach them to a 110-Volt, Non-Switched Source on the spa pac. This is the most attractive method because it eliminates having to run an electrical cord from your home. It only draws 2 amps of current, so it shouldn't interfere with the Spa Pac's permitted amperage draw.

**WARNING:** DIRECT WIRE TO THE SPA PAC installations Should ONLY be done by a Licensed Electrician or a Certified Spa Technician.

Figure 85



Figure 86



Figure 87



Figure 88

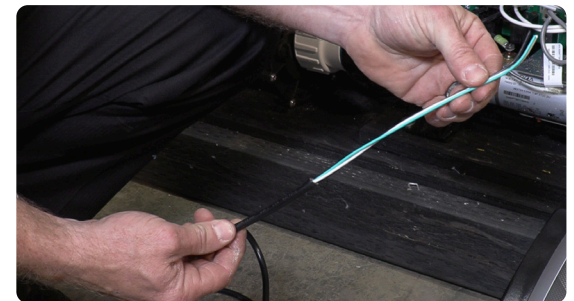
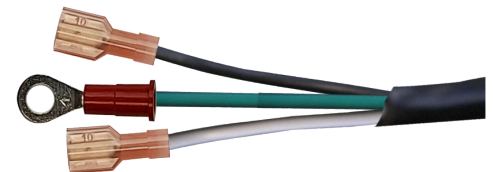

Figure 89



## 25.2 DEDICATED 110V FROM YOUR HOME

Run a dedicated 110 Volt line to your Power Supply from either the main electrical panel in your home or from the external sub panel for your spa. Cut and strip the lines of your Power Cord and these lines to the Dedicated 110 Volt line from your home. Attach these lines within a Weatherproof Box kept within the interior of your spa. Then splice and connect them to the 110 Volt line within a Weatherproof Junction Box. See Fig 90

**WARNING:** DEDICATED 110V installations Should ONLY be done by a Licensed Electrician in accordance with local codes.

## STEP 29, FINAL TEST

Test again the Key Switch and the remote if you have one. If all works well, Congratulations, your installation is successful.

Enjoy your hot tub and remember to complete the warranty information card.

Figure 90

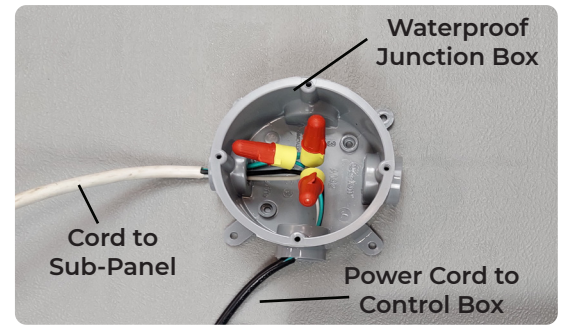

# Keyswitch Installation Template

Attach this template to the spa as shown.

## DIRECTIONS:

1. Cut along the dotted line.
2. Tape Side A at the lowest part of Spa Shell against the Shell Coping.
3. Tape Side B at the top of the Spa Cabinet against the Shell Coping

This helps you determine the horizontal position of the hole for the Key Switch.

Be certain the hole is at least 1 1/2" down from the top of Spa Cabinet then mark position of the hole with a pencil. You're now ready to drill.

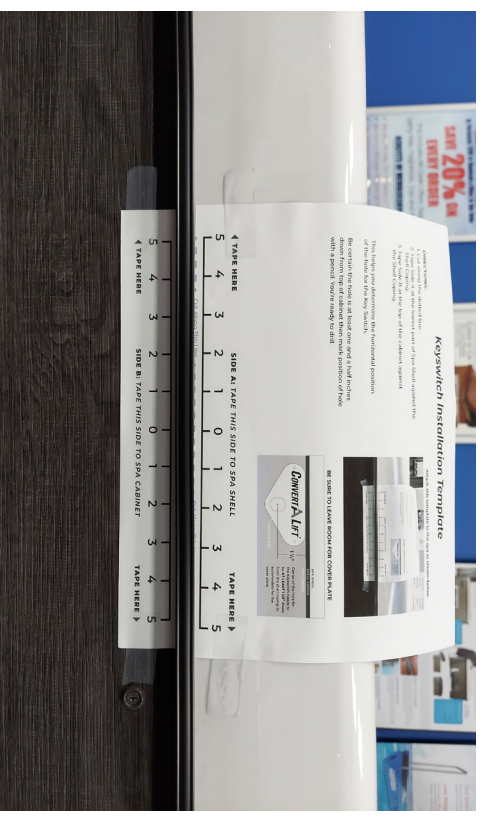

**BE SURE TO LEAVE ROOM FOR COVER PLATE**

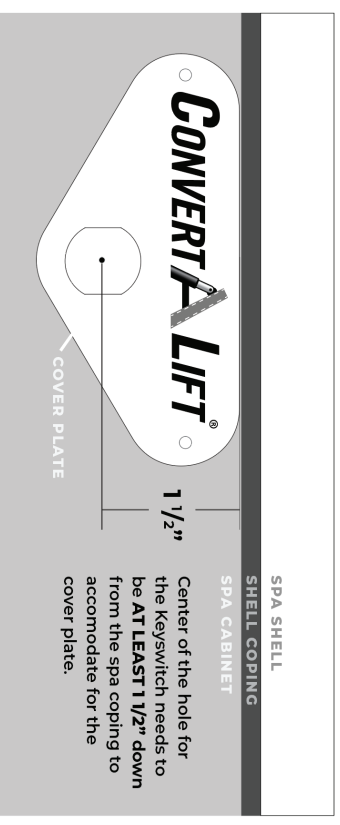

▶ **TAPE HERE**      **SIDE A: TAPE THIS SIDE TO SPA SHELL**      **TAPE HERE** ▶

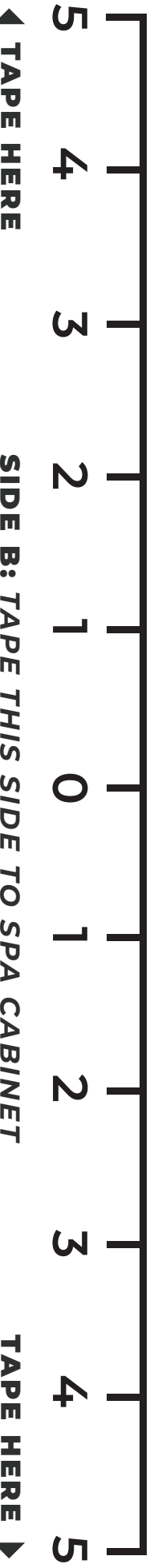

▶ **TAPE HERE**      **SIDE B: TAPE THIS SIDE TO SPA CABINET**      **TAPE HERE** ▶