

Installing **CONVERTALIFT**[®]

Automatic Cover Lifter & SpaEase 200

For Video Instruction Manual go to: ConvertALift.com

To install a ConvertALift and a SpaEase 200 System on a hot tub requires 2 items.

1. ConvertaLift System
2. SpaEase 200 Lifter

Disregard the manual in the SpaEase 200 Lifter and follow this manual.

If you have any questions, please call us at 860 469 2580

Hot Tub Products, LLC

2 Toelles Road, Suite 13, Wallingford CT

Email: info@hottubproducts.com

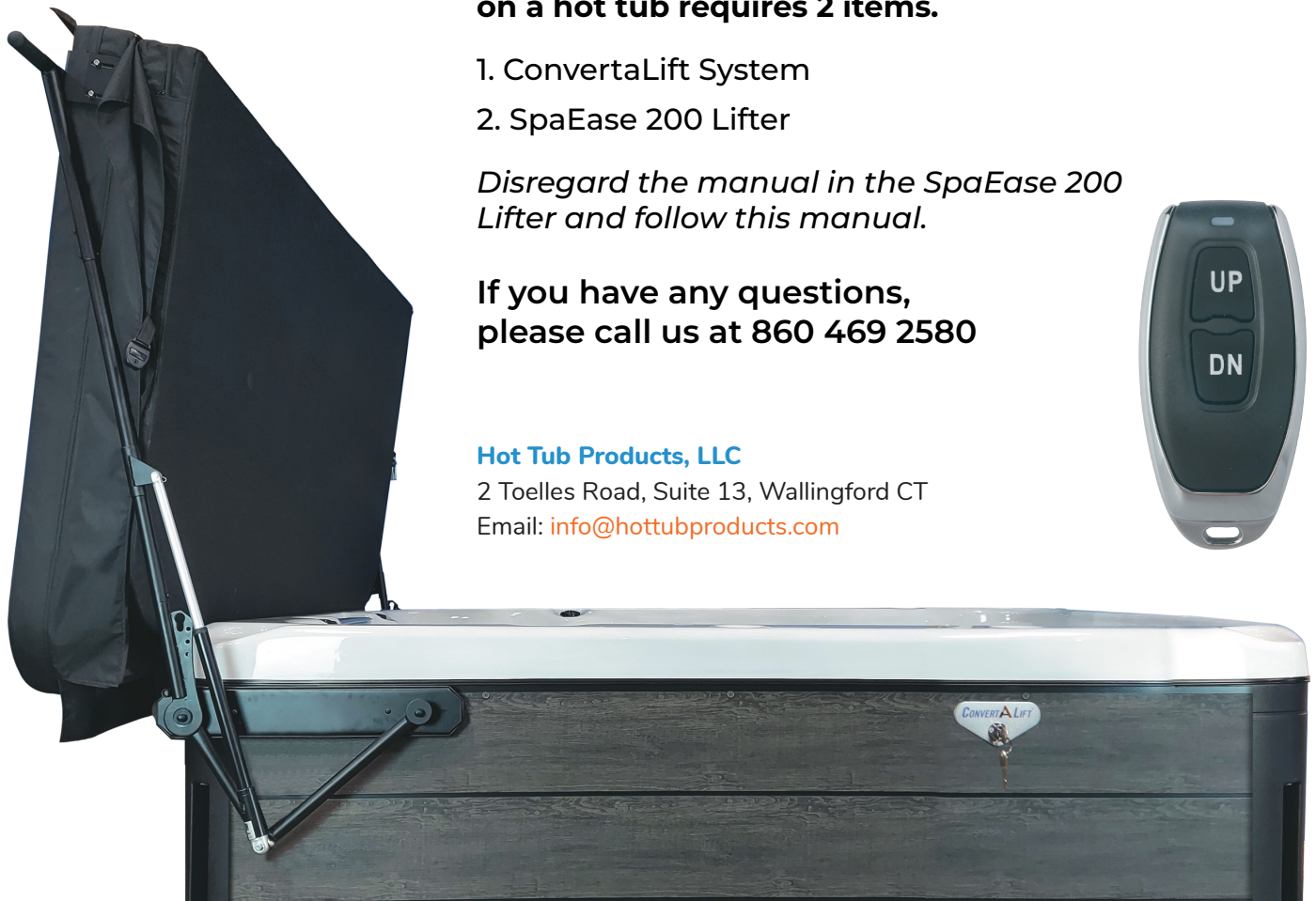

Table of Contents

Spas Not Suitable for Installation & Clearance Requirements.....	3
ConvertALift Parts List	4
Pre-Installation Instructions	5
STEP 1 - Turning Power Off & Positioning Cover, STEP 2 - Installing Control Box & Power Supply.....	6
STEP 3 - Attach All Extension Cables to Control Box, STEP 4 - Installing Key Switch Assembly	7
STEP 4 - Installing Key Switch Assembly (Continued)	8
STEP 5 - Installing the Actuator Cables.....	9
STEP 5 - Installing the Actuator Cables (Continued).....	10
STEP 5 - Installing the Actuator Cables (Continued), Step 6 - Installing the Mounting Bracket	11
STEP 7 - Installing the Cover Plate, STEP 8 - Installing V-Bar, STEP 9 - Installing Swing Arm, STEP 10 - Installing Adjustable Bracket & Crossover Bar on Swing Arm,	12
STEP 12 - Sliding Extension Tube Into Crossover Bar, STEP 13 - Installing 2nd Crossover Bar, STEP 14 - Installing 2nd Swing Arm, Step 15 - Installing the Handle, Step 16 - Secure Croosover Bars to Swing Arm	13
STEP 17 - Secure Crossover Bars to Extension Tube, STEP 18 - Installing Linear Actuators, STEP 19 - Securing Adjustable Brackets to Swing Arms, Step 20 - Testing the ConvertALift System.....	14
STEP 21 - Securing the Bottom Holes on Adjustable Brackets, STEP 22 - How to Properly Open & Close the SpaEase 200 Cover, STEP 23 - Installing Plastic Caps & Plugs	15
STEP 24 - For Systems with Remote Control, STEP 25 - Powering the ConvertALift, STEP 26 - Final Test	16
Key Switch Assembly Installation Template	17

Spas Not Suitable for Installation & Clearance Requirements

CONVERTALIFT CHANGES:

1. A cabinet height less than 12" between the ground and the bottom of the shell coping. See Fig A
2. Hot Tubs longer than 108" (Over 96" are special order and require approval by cover supplier)
3. Hot Tubs wider than 110"
4. Round spas, or those with a radius 17" or larger. See Fig B

IMPORTANT: Spas with a radius above 12" and up to 16" require ordering and installing an optional "VacuSeal Extended Bracket". It includes 2 brackets that mount to each Mounting Bracket and their adjoining cabinet panels.



Also be sure to leave about 7" of space for your cover to rest in the open position (See Fig C) and that there is adequate space around the perimeter of the spa to install the SpaEase 200 and ConvertALift equipment.

Figure A

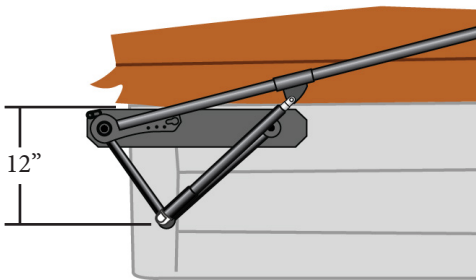

Figure B

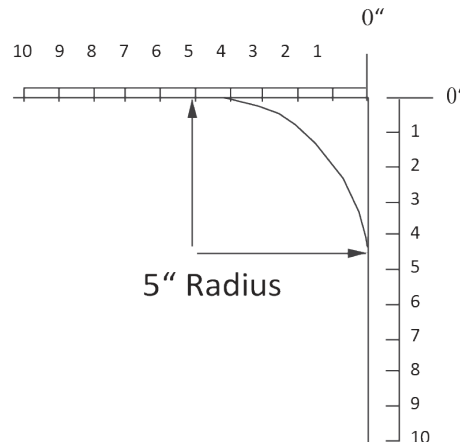
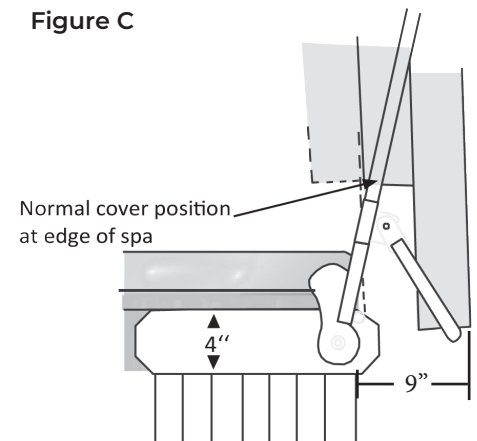

Figure C



IMPORTANT: FOR SWIM SPAS ONLY

Installing the VacuSeal and ConvertALift Systems on a Swim Spa requires certain changes to each system.

CONVERTALIFT CHANGES:

1. The Control Box is Different.
 - a. It is designed to operate each side independently.
 - b. There are 4 Actuator Extension Cables, 1 for each Actuator.
2. You need to install 2 Key Switch Systems. One for each cover.
3. Remote Control can open each side independently but for safety purposes, does not allow closing the cover with the remote.

ConvertALift Parts List

Keyswitch Assembly

Includes:

1. Pigtail Cable PART# CLP-ADKS
2. Key Cover Plate PART# CLP-KYCP
3. Key Switch Nut PART# CLP-KYNT
4. Key Switch Cylinder PART# CLP-KWCY
5. Keys PART #CLP-KYKY

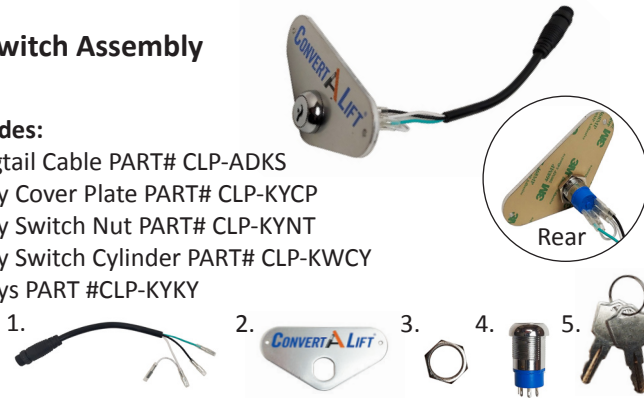

Controller (1)

PART #CLP-CTHT

Key Fob (2)

PART #CLP-KFHT



Power Supply (1)

PART #CLP-PSHT-2

Power Supply Cord (1)

PART #CLP-PSHT-2



Linear Actuator (2)

PART #CLP-EA28



Actuator Extension Cable 16' 2 Pin (2)

PART #CLP-ECEA



Key Switch Extension Cable 10' 3 Pin (1)

PART #CLP-ECKS



V-Bar

PART #CLP103



ConvertALift Adjustable Bracket (L&R)

Left - PART #CLP104L Right - PART #CLP104R

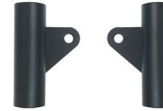

Zip Tie 15" (2)

PART #CLP113

Zip Tie 6" (2)

PART #CLP113

Hardware

2" Hex Bolt 5/16" #18 (2)

PART #CLP108



Bushing Sleeve (2)

PART #CLP105



Clevis Pin (2)

PART #CLP-111



Cotter Pin (2)

PART #CLP107



2" Black Metal Washer (2)

PART #CLP106



#10 5/8" Self Tapping Screw (8)

PART #VS113



5/16" Hex Bolt .75" Long (2)

PART #VS124



Key Switch Screws #4 3/4" (2)

PART #CLP109



Female Spade Connectors (3)

PART #CLP115



Ring Terminal Connector (1)

PART #CLP115



Small Plastic Caps

PART #VS118

Large Plastic Caps

PART #VS117

TOOLS REQUIRED

- Screw Gun
- Wrenches:
 - 1/2"
 - 7/16"
- Drill Bits:
 - 9/64"
 - 1/8"
- Hole Saws:
 - 5/8" (Optional)
 - 1 1/8"
- Tape Measure
- Phillips Screwdriver
- Template

Recommended:

- Cable Running Rods
- Wood Clamp
- Tube Cutter
- Electrical Tape

Before Installing ConvertALift & VacuSeal System Together

Pre-Installation Instructions

For the purpose of this installation, the Service Panel is the side where your spa pac is located. The opposite side we will call the Rear Panel and the others will be the Right and Left Side Panels.

Before beginning the installation, you need to:

1. Choose the direction of the cover.
2. Select how to power your system.
3. Decide where to install the Power Supply.

1. CHOOSING COVER DIRECTION

We recommend having the cover move away from the Service Panel and towards the Rear Panel.

This eliminates having to remove mounting brackets for potential service in the future, along with allowing easy access to your control panel when the cover is open. See Fig 1

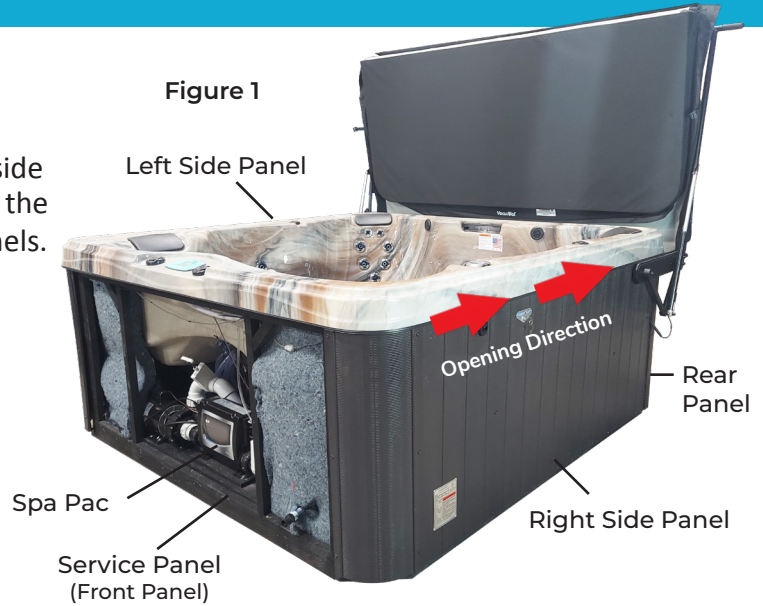

2. SELECTING POWER SYSTEM

There are 2 recommended ways to power the ConvertALift. For instructions on each method See **STEP 28**

1. Direct to Your Spa Pack



Requires wiring your Power Supply to a 110-Volt, Non-Switched Source on your hot tub's Spa Pac.

BENEFIT: It eliminates having to run an external cord from your home.

WARNING: Must be done by a Licensed Electrician or a Certified Spa Technician.

2. Dedicated 110V Line From Home

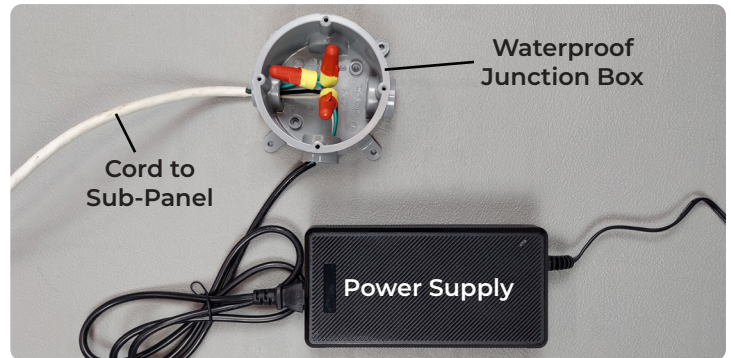

Running a Dedicated 110 Volt Line from your home's electrical panel and wiring it directly to the Power Supply using a waterproof junction box.

BENEFIT: It allows you to install Power Supply behind Service Panel or Rear Panel.

WARNING: Must be done by a Licensed Electrician in accordance with local codes.

3. DECIDING WHERE TO INSTALL POWER SUPPLY

1. Direct to Your Spa Pack

Powering your ConvertALift "Direct to Your Spa Pac" requires you install Power Supply behind the Service Panel.

2. Dedicated 110V Line From Home

Powering as a "Dedicated 110V Line" from your home allows you to choose installing the Power Supply behind the Service Panel or the Rear Panel.

Installing ConvertALift & VacuSeal System Together

IMPORTANT: Before you begin the installation please read all the safety precautions provided within the ConvertALift written instruction manual.

STEP 1 - TURNING POWER OFF & POSITIONING COVER

- 1.1 If you are installing the power supply behind the service panel, turn off the power to your hot tub and keep it off until the installation is complete.
- 1.2 Position cover squarely on the spa checking each corner. See Fig 2

Figure 2



STEP 2 - INSTALLING CONTROL BOX & POWER SUPPLY

IMPORTANT : Install all components at any elevated position to keep them protected from any potential ground water.

- 2.1 Remove the cabinet panel where you have chosen to install the Power Supply. See Fig 3
- 2.2 First secure the Control Box using a 15" Zip Tie. See Fig 4

IMPORTANT : Do not position the Control Box on any stereo equipment it can prevent it from operating.

Figure 3

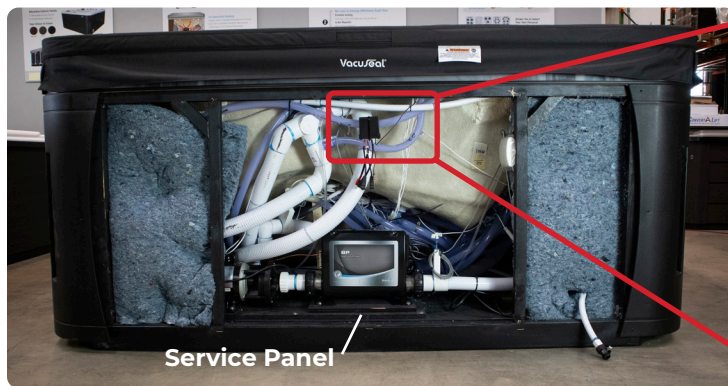
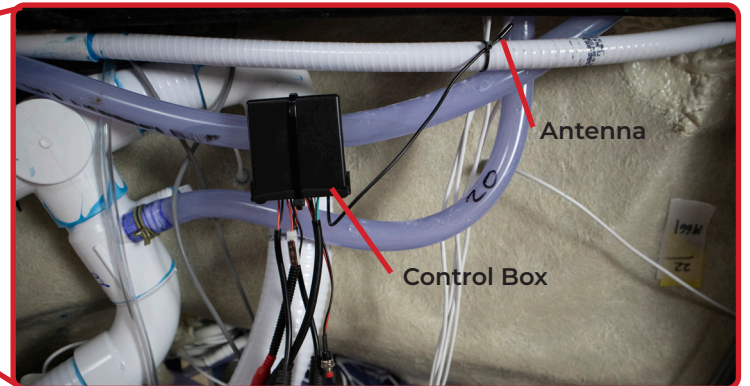

Figure 4



- 2.3 Secure the antenna also in an elevated location with a 6" Zip Tie. See Fig 4
- 2.4 Plug the attached cord on the Power Supply into the red colored pigtail on the Control box. See Fig 6
- 2.5 Plug the input end of the 5 1/2' Power Cord fully into the Power Supply. See Fig 7
- 2.6 Position the Power Supply anywhere in the cabinet, but leave the end of the Power Cord within reach. If the spa is being delivered after the installation, it's a good idea to secure the Power Supply with a 15" Zip Tie so it won't move during transport.

NOTE: The Power Supply is adaptable for both US (that use 60 HZ electrical systems) along with 50 HZ electrical systems (that is used in many international countries.) The only change required is the Power Cord. Please be certain to order it in advance if you are installing the ConvertALift on a 110V 60 HZ or a 220V 50 HZ hot tub. See Fig 5

Figure 5

Power Supply



Figure 6

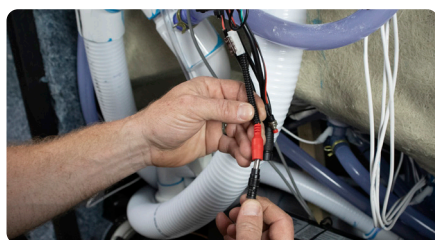

Figure 7



IMPORTANT: Make certain Power Cord is plugged into Power Supply completely or malfunction may occur.

STEP 3 – ATTACH ALL EXTENSION CABLES TO CONTROL BOX

NOTE: All Extension Cables are Directional, which means that one side is a male connection and the other a female. Plugging each one into the corresponding Pigtail on the Control Box helps prevent an error that would require you to rerun the cable. See Fig 8, 9 and 10

3.1 Both Actuator Extension Cables have 2-Pin Connections. Plug each of them into the 2 pin Pigtail Connectors off of the Control Box. See Fig 8

3.2 The Key Switch Extension Cable has a 3-Pin Connection. Plug it into the 3 pin Pigtail Connector off the Control Box. See Fig 9

3.3 Leave all cables accessible with the panel remaining off. See Fig 11

Figure 11



Figure 8

Actuator Cable End



Figure 9

Key Switch Cable End



Figure 10

Control Box Connections:

A. Actuator Cable Connectors (2 -Pin)

B. Power Supply Connector

C. Button for Programming Remote

D. Key Switch Cable Connector (3-Pin)

E. Antenna

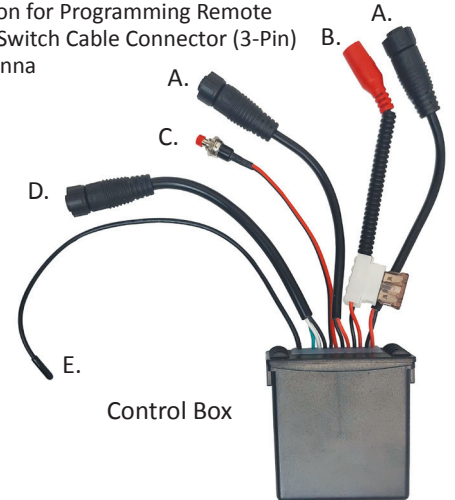

STEP 4 - INSTALLING KEY SWITCH ASSEMBLY

4.1 Check that the wires and the rear Lock Nut are secure on the Key Switch Assembly. Do not remove the adhesive paper behind the plate. See Fig 11A

NOTE: If any wires have become disconnected attach the 2 White Wires to either of the two center connections labeled 1 and 8. And the Green and Black Wires to outside connections labelled 2 & 7. See Fig 11B

4.2 Determining Key Switch Location.

NOTE: Key Switch should be installed on the side you would normally enter your spa that includes a Mounting Bracket. And is positioned anywhere from 60% to 80% from the end of the cabinet where the cover opens and at a height convenient for the user to operate. Installing the Key Switch requires you to drill a hole in the cabinet panel. See Fig 12

Figure 12

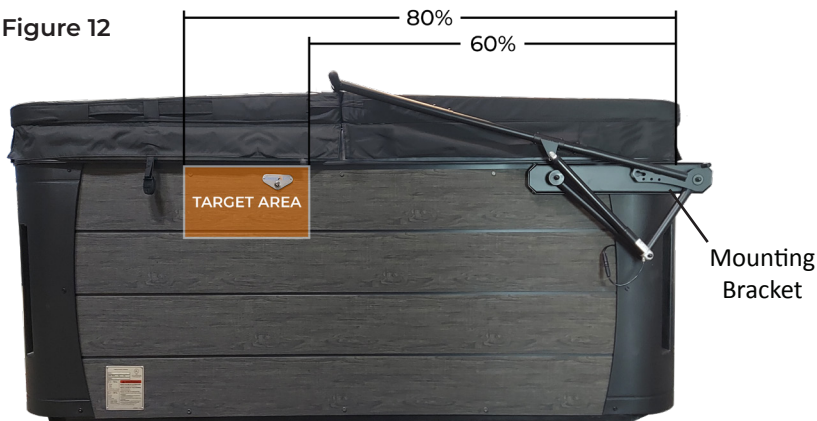

Figure 11A

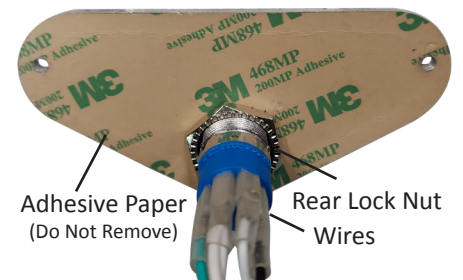
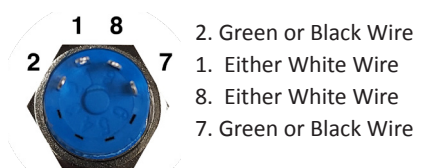
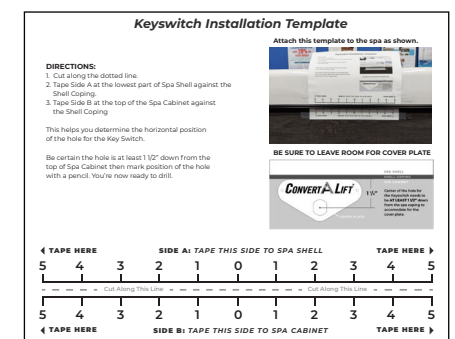

Figure 11B



Switching wires 2 & 7 will change the direction the key operates.

Figure 13



IMPORTANT: If you are uncertain if there is an obstruction where you are planning to drill the hole then you should remove the panel and use the Template provided. See Fig 13

See detailed instructions for using the Template on the next page.

STEP 4 - INSTALLING KEY SWITCH ASSEMBLY (CONTINUED)

USING THE TEMPLATE: Cut along the dotted line and then tape Section A at the bottom of the shell coping and B along the top of the cabinet. (See Fig 14) Then remove the cabinet panel. This helps you determine the horizontal position of the hole. See Fig 15 Be certain the hole is at least one and a half inches from top of cabinet then mark the position of the hole. See Fig

Template Cut & Taped to Coping & Cabinet

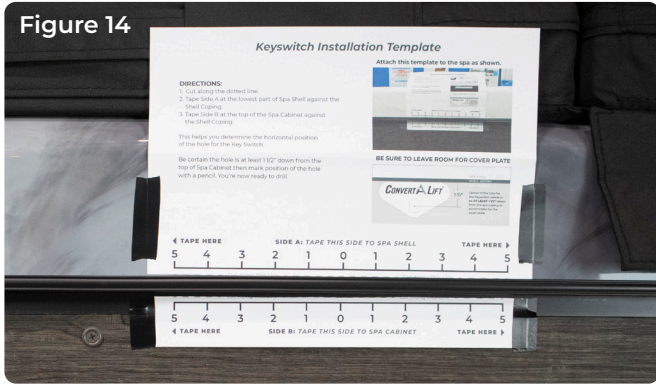

Panel Removed

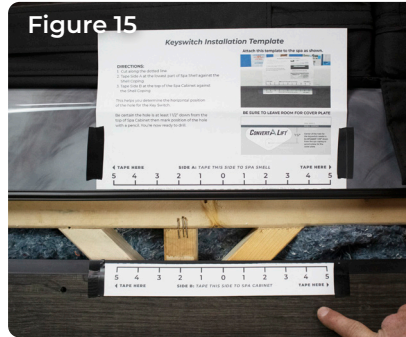

Figure 16

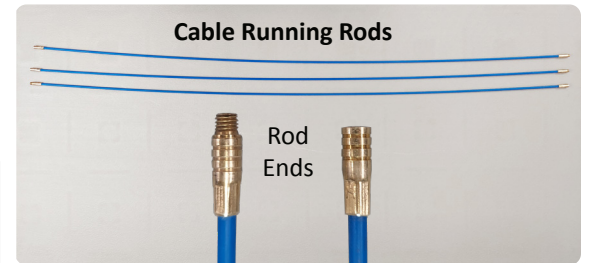

Figure 17

4.3 Using a 1 1/8" Hole Saw drill a hole in the cabinet panel. See Fig 16

4.4 Position Key Switch Extension Cable in Target Area.

NOTE: We recommend using Cable Running Rods. We make available a package of three, 3' Foot rods, that can be screwed together to extend up to 9 Feet. See Fig 17



There Are Two Ways Run the Cable to the Target Area

4.4A Feeding Key Switch Cable from Control Box



4.4A Feeding Key Switch Cable From Control Box

With the Side Panel removed, you may be able to simply hand feed the cable from Control box and then grab the cable and pull it through the hole. Having a removable Corner Panel on the cabinet also makes it more possible. See Fig 18

4.5 Connect the Key Switch Pigtail to the Extension Cable.

Make sure the wiring is secure before placing it through the hole then secure the Key Switch Plate with one screw. Check to be certain the Plate is level and then secure with the second screw. See Fig 23



4.4B Snaking a Cable Rod Through Hole



4.4B Snaking a Cable Rod Thru the Hole

Re-attach the Side Panel with the hole already drilled, and snake a Cable Running Rod through the hole towards the control box. (See Fig 19) Securely tape the Key Switch Extension Cable to the Cable Running Rod. (See Fig 20) and then pull the Rod through the hole until you can grab onto the cable. See Fig 21

Figure 20



Figure 21

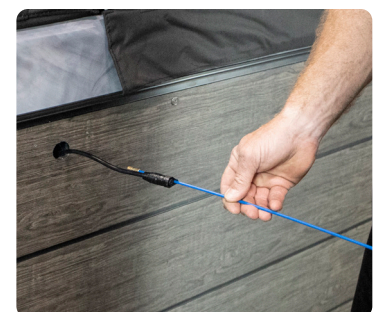

STEP 5 - INSTALLING THE ACTUATOR CABLES

NOTE: Installing the Actuator Cables often (but not always) requires two steps.

1. Running the Extension Cables to the Corners of the Cabinet. See 5.1
2. Positioning the Cable Ends in the Target Area. See Step 5.2 and Fig 23

Figure 23

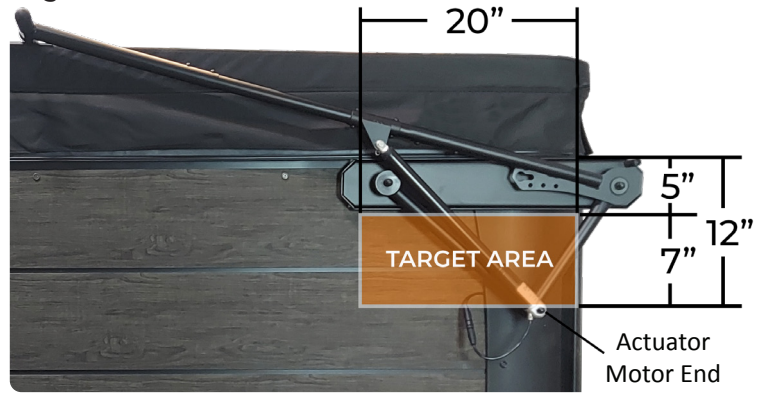

HELPING YOU DETERMINE LOCATION OF THE POWER SUPPLY

Figures 24A & 24B demonstrate that installing the Actuator Cables is easiest when the Power Supply is on the side closest to the Mounting Brackets. **BUT NOTE:**

1. The location of the Mounting Brackets determine the side where the Cover opens to and it is preferred (not required) to have the Control Panel opposite the cover so that it is convenient to access it when the cover is closed.
2. Control Panels on most hot tubs are located on the same side as the Spa Pac. And if you are attaching the Power Supply to the Spa Pac, they must be within 5 feet each other.

Figure 24A

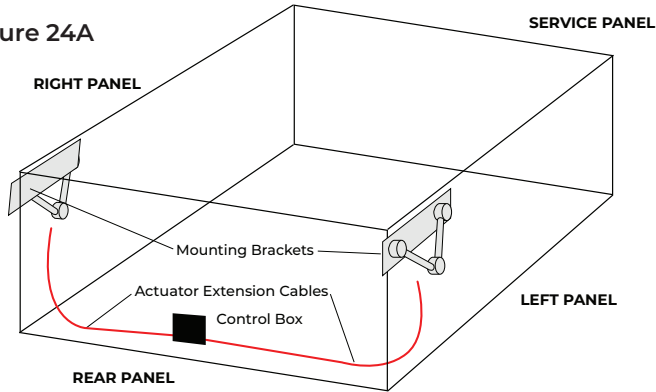
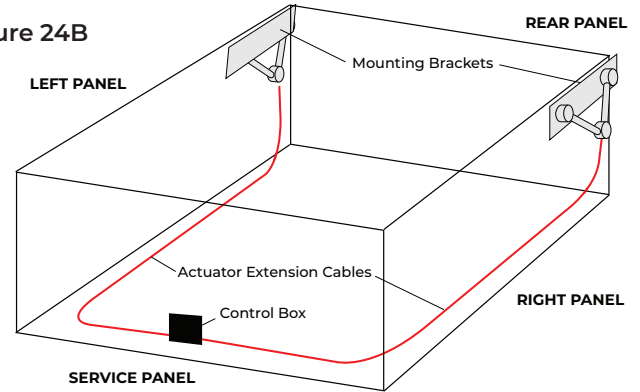

Figure 24B



5.1 Running the Extension Cables to Corners of Cabinet

There are 3 methods to choose from to run the Cables to the Corners of the Cabinet:

5.11 Snaking the Cables Through the Cabinet Interior



5.12 Positioning Cables Behind Cabinet Side Panels

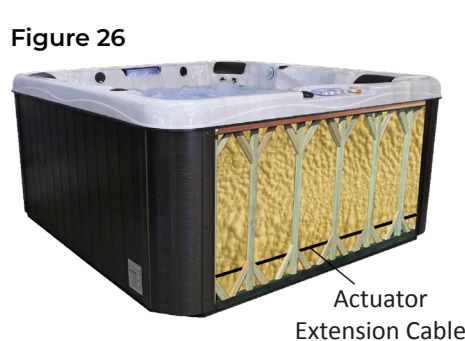

5.13 Running Cables Along Cabinet Lower Perimeter

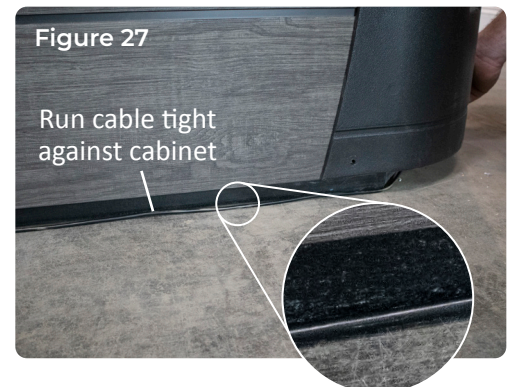

Detailed Instructions for Each of These Methods on the Next Page

IMPORTANT: Careful Not to Pinch Cables or to Bend Them at Less Than a 1" Radius.

STEP 5 - INSTALLING THE ACTUATOR CABLES (CONTINUED)

5.11 Snaking the Cables Through the Cabinet Interior (Continued)

Remove the Corner Panels where the Mounting Brackets are to be installed. If they are not removable, remove the Rear Panel. Then feed a Cable Running Rod (or something similar) from that panel, through the interior of the cabinet, towards the Control Box where the Actuator extension cables are located. See Fig 28

Make sure to leave enough of the Cable Rod to grab onto. See Fig 29

Go to the Control Box, capture the Cable Rod and securely tape it to the Actuator Ext Cable. See Fig 30

Then go back to Corner Panel, grab hold of Cable Rod and pull it through the spa's interior until you can capture the taped end of the extension cable. See Fig 31

NOTE: This procedure can also be done with a broom handle just not as easily.



5.12 Running the Cables Behind the Side Panels

Remove the Side Panels and position the Actuator Extension Cable behind the Panels. If the interior of the spa is fully foamed the Extension Cables are thin enough to go between the panels and the insulation. If necessary, position cables behind any framing material. See Fig 32

Figure 32

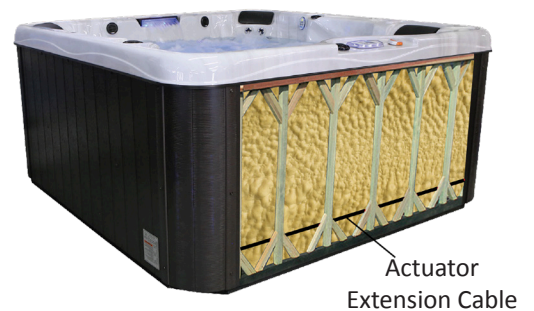

5.13 Running Cables Along Cabinet Lower Perimeter

The easiest method of running the Actuator Extension Cable is positioning them along the lower perimeter of the cabinet. (See Fig 33). If you choose this method then it is strongly recommended to secure the cable somehow, either with a cover board or removing the screws on the bottom of cabinet and securing them inside along the bottom of the cabinet. Left unsecured, the cable will become loose and open for damage. See Fig 34

Figure 33



Figure 34



**REPEAT YOUR CHOSEN METHOD
ON THE OTHER SIDE(5.11, 5.12 or 5.13)**

STEP 5 - INSTALLING THE ACTUATOR CABLES (CONTINUED)

5.2 Positioning Cable Ends in the Target Area

There are 3 methods to choose to position Cable Ends in Target Area

5.2.1 Behind the Corner Panel



Most Preferred Method

5.2.1 Remove the Corner Panel where the Mounting Bracket would be installed. Then Slide the Cable to a point where it is within the Recommended Target Area. Then reinstall the Corner Panel to secure the Cable. See Fig 35

5.2.2 Through a Hole in the Cabinet



5.2.2 Drill a 5/8" Hole Saw drill a hole in the Target Area. See Fig 36

Note: Be sure there is no obstruction behind the cabinet panel and feed the Extension Cable through it. This may require removing the Side Panel.

5.2.3 Installing Cable within U Channel

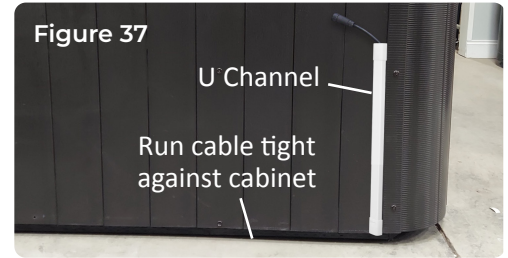

5.2.3 Installing Cable within a 5/8" or larger U Channel on the cabinet. Install the U Channel from the bottom of the cabinet to the point in the Target Area. See Fig 37

Note: This is not the most attractive method but ideal for customers with cabinets that have no Removable Corner Panel or for those not wanting to drill a hole in their cabinet.

STEP 6 - INSTALLING THE MOUNTING BRACKET

REMINDER If the Radius of your cover is greater than 12" and less than 16" you need to use our optional "Extended Bracket". To install the Mounting Bracket requires attaching the an Extended Bracket to each of the Mounting Brackets. Once attached simply position them squarely on each corner and use that position to secure each Mounting Bracket. More detailed instructions are within the package. If your Radius is greater than 16" then our product will not properly attach to your spa. See Fig 38

OPTIONAL EXTENDED BRACKET FOR LARGE RADIUS SPAS



NOTE: Mounting Brackets are to be installed on each Side Panel and to the rear of the spa, where the cover is intended to be positioned when open.

INSTALLING MOUNTING BRACKETS ON SPAS WITH A RADIUS OF 12' OR LESS

- 6.1** Position Mounting Bracket flush with the back of the coping of the spa shell and mark the cabinet with a pencil. See Fig 39
- 6.2** If unknown to you, check to see if there is a solid structure to screw into. If necessary, install supports to the spa frame, usually short 2x4 material works fine.
- 6.3** Position the Mounting Bracket at your pencil line, flush under the spa coping. Make sure the safety stop is at the top and rear of the spa. Fig 40
- 6.4** The mounting bracket must sit flush on the cabinet. If it doesn't, remove any protruding screws and add a wood spacer to level the area off. Fig 41
- 6.5** Hold bracket in position and pre-drill two holes with a 1/64" drill bit to prevent splitting wood. See Fig 42
- 6.6** Secure the 2 holes with Wood Screws. Secure the Mounting Bracket with a minimum of 8 Wood Screws, though more is always better. Fig 44

Figure 39



Figure 40



Figure 41

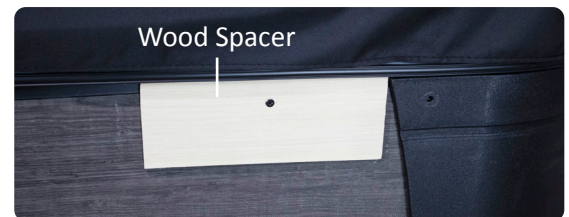

Figure 44

Figure 42



Figure 43



NOTE: On spas with STEEL FRAMES use a Metal Bit to Pre-drill all holes and then securing with Wood Screws will work just fine.

STEP 7 - INSTALLING THE COVER PLATE

- 7.1 Position Cover Plate over Mounting Bracket and secure with 2 machine screws using a hand-held Phillips Screwdriver. See Fig 45

STEP 8 - INSTALLING THE V-BAR

- 8.1 Slide the V-Bar over the 2 Bosses on the Mounting Bracket with the short side closest to the rear of the spa. See Fig 46
- 8.2 Place a 2" Black Metal Washer on the Mounting Bracket Boss furthest from the rear of spa and attach with a Short 1/2" Hex Bolt. Fig 47 & 48

Figure 46



Figure 47



Figure 45



Figure 48



REPEAT STEPS 6 – 8 ON THE OTHER SIDE

STEP 9 - INSTALLING THE SWING ARM

- 9.1 In your hand hold a Short 1/2" Hex Bolt and place a locking washer over it, then add a Black Machined Washer, followed by a Teflon washer. See Fig 49
- 9.2 Then place a separate Teflon washer over the Boss closest to the end of the spa. See Fig 50
- 9.3 With the other hand position the swing arm on the Boss with the flat extended plate pointing down. Rest Swing Arm down. See Fig 51
- 9.4 Install Hex Bolt assembly in your hand, keeping washers even, then firmly tighten with a 1/2" wrench until lock washer is compressed.

Figure 49

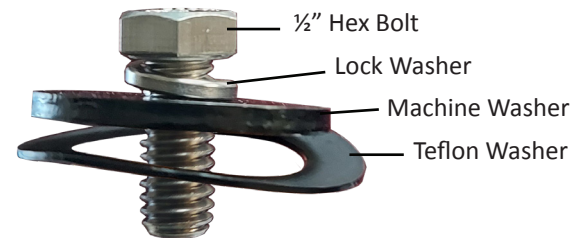

Figure 50



STEP 10 - INSTALLING ADJUSTABLE BRACKET & CROSSOVER BAR ON SWING ARM

- 10.1 Slide the ConvertALift Adjustable Bracket on the Swing Arm with the triangular plate positioned furthest from the spa and the short side toward the rear of the spa. See Fig 51
- 10.2 Slide shorter side of Crossover Bar over the Swing Arm at a point where the long side of the Crossover Bar lies along the hinge of the Cover. See Fig 52

Figure 51



LEAVE BOTH THE ADJUSTABLE BRACKET AND THE CROSSOVER BAR UNSECURED TO SWING ARM

IMPORTANT: If cover is less than 78" long you will have to cut both Swing Arms with a tube cutter. If you cut the Swing Arms be sure it remains visible through the pre-drilled holes in the Crossover Bar.

Figure 52



STEP 12 - SLIDING EXTENSION TUBE INTO CROSSOVER BAR

- 12.1 The Extension Tube is 40" long. Put a pencil mark at the 20" center point which will assist you later in the installation. See Fig 53
- 12.2 Slide Extension Tube partially into the Crossover Bar and leave it unsecured.

STEP 13 - INSTALLING SECOND CROSSOVER BAR (SAME AS OTHER SIDE)

- 13.1 Slide the longer side of the second "Crossover Bar" onto the Extension Tube. Make certain to keep center point of Extension Tube visible. See Fig 54
- 13.2 Check that the pencil mark on the extension tube is centered. See Fig 54

LEAVE ALL PARTS UNSECURED

NOTE: If cover width is less than 66" you will need to cut both sides of the Crossover Bars. Ideally cut both of them equally to provide symmetrical appearance.

STEP 14, INSTALLING SECOND SWING ARM (SAME AS OTHER SIDE)

- 14.1 Place a Teflon washer over the Boss.
- 14.2 Slide the ConvertALift Adjustable Bracket on the Swing Arm just as was done on the other side.
- 14.3 Then Slide the ConvertALift Brackets on the Swing Arm. Then slide it into the Crossover bar and just like on the other side, do not secure it. Then position it on the boss and secure with the same hardware as before.

STEP 15 - INSTALLING THE HANDLE

- 15.1 Slide Handle fully into the Crossover Bar that is on the same side as the Key Switch and leave unsecured. See Fig 59 - 60

NOTE: Handle will act as a convenient robe holder, also for use in emergency situations.

STEP 16 - SECURE CROSSOVER BARS TO SWING ARMS

- 16.1 **IMPORTANT**, check that the Cover sits evenly on all sides and on each corner. See Fig 57
- 16.2 Measure the distance "X" from "Open End of Swing Arm" to its "Connection Point" on Crossover Bar. (See Fig 58) Make certain the distance on both sides is exactly the same. Shift the cover if necessary.
- 16.3 Make certain both sides are running parallel and that there is clear, even space between Swing Arm and the cover so that it will open without any obstruction. See Fig 57
- 16.4 Pre-drill holes in the Crossover Bar with a 5/32" drill bit then secure it to the Swing Arm with self-tapping screws. See Fig 55 & 56

REPEAT ON THE OTHER SIDE

Figure 53

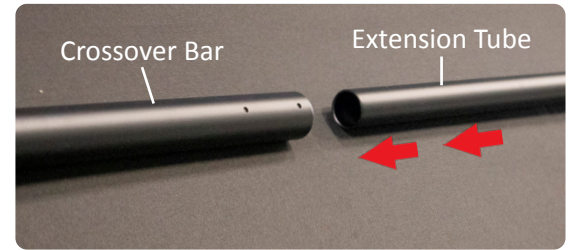

Figure 54

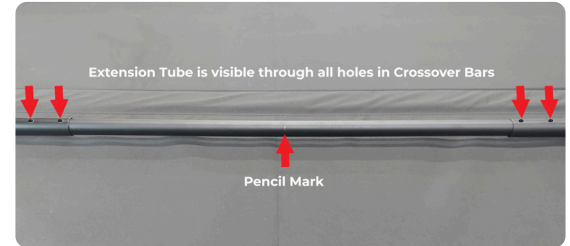

Figure 55

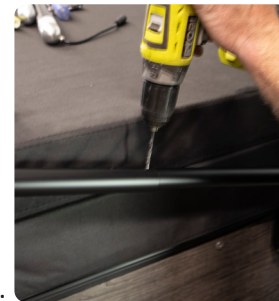

Figure 56

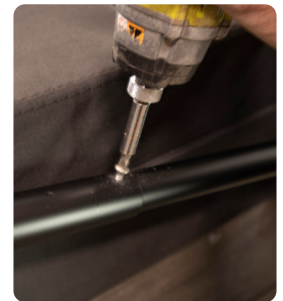

Figure 57



Figure 58

Connection Point

IMPORTANT: Measurement "X" needs to be the same on both sides of spa.

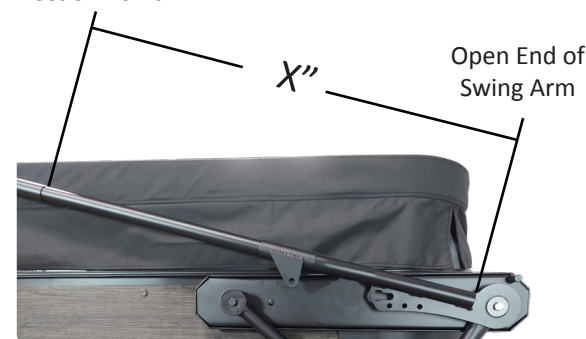

STEP 17 - SECURE CROSSOVER BARS TO EXTENSION TUBE

WARNING: Make certain to use a hard, protective material to protect potential damage to the cover before securing Crossover Bar to Extension Tube. **Damage is not covered under warranty.** See Fig 69

- 17.1 Check that Extension Tube is visible, then pre-drill holes using a 5/32" drill bit.
- 17.2 Secure with Self-Tapping Screws. See Fig 61

STEP 18 - INSTALLING LINEAR ACTUATORS

- 18.1 Slide a Bushing Sleeve onto the Long 1/2" Hex Bolt and then slide the bolt into the bottom hole of the Actuator with cable pointing down. See Fig 62 & 63
- 18.2 Position Actuator over the bottom of the V-Bar and secure it tightly using a 1/2" wrench.
- 18.3 Position the other side of the Actuator over the Adjustable Bracket plate, line up the holes, and slide in the Clevis Pin. See Fig 64,65 & 66
- 18.4 Secure Clevis Pin with the Retainer Clip into the first notch.
- 18.5 Attach Actuator Extension Cable to Pigtail Cord on the Actuator and leave a short bottom loop to prevent rainwater from running directly to Actuator Motor end. See Fig 67

Figure 64



Figure 65



Figure 66



Figure 67



Figure 59



Figure 60



Figure 61



Figure 62



Figure 63



STEP 19 - SECURING ADJUSTABLE BRACKETS TO THE SWING ARMS

- 19.1 Secure the ConvertALift Adjustable Bracket to the Swing Arm by installing self-tapping screws into the two top holes. The bottom holes will be secured later. See Fig 68

REPEAT STEP 18 & 19 ON THE OTHER SIDE

STEP 20 - TESTING THE CONVERTALIFT SYSTEM BY PLUGGING IN THE POWER SUPPLY

- 20.1 Attach the plug from the Power Cord to any approved outdoor extension cord and plug that cord into any GFCI protected outlet. Fig 69

WARNING: This is not a recommended installation, but it's ideal for testing your system prior to it being permanently wired.

Figure 68



Figure 69



WARNING: Make Certain No Cover Straps are Attached to the Cabinet. If Attached, it can Cause Damage to the Spa and/or the Cover and Neither are Covered Under the Warranty. See Fig 70,71

20.2 Once the power supply is plugged-in fold the cover in half and use the Key Switch to raise the cover. If it raises the cover then move on to the next step. Do not close the cover, leave it in the open position. If turning the Key Switch either way produces no activity there are 3 primary causes. If none of these caused the failure, then visit the ConvertALift Trouble Shooting Guide and/or call your dealer.

1. One of the wires on the back of the Key Switch became disconnected. Remove the two screws on the Key Switch Panel, gently pull out the Key Switch and reattach any disconnected wire. Also check that the Key Switch Pigtail is properly connected to the Key Switch Extension Cable.

2. Check that the Power Cord is properly secured into the Power Supply. If neither of these are the problem, visit the ConvertALift Trouble Shooting Guide.

3. Check to see if the GFCI breaker has tripped

STEP 21 - SECURING THE BOTTOM HOLES ON THE ADJUSTABLE BRACKETS

21.1 With the cover up, use self-tapping screws to secure all lower holes in the bottom of the VacuSeal and the ConvertALift Adjustable Brackets. Fig 72

REPEAT ON THE OTHER SIDE

STEP 22 - HOW TO PROPERLY OPEN & CLOSE THE SPAEASE 200 COVER

To open first fold the cover in half. Then turn the Key Switch until the cover fully opens. To close, turn the Key Switch until the first half of the cover fully closes, then manually fold the second half of the cover over.

STEP 23 - INSTALLING PLASTIC CAPS AND PLUGS

To give your spa a finished look, install small caps on all self-tapping screws, medium caps on mid-sized bolts, and Large caps on large bolts. (See Fig 84, 85 & 86) Plus be sure to put rubber sleeve on safety stop, medium sized plugs on open ends of Rear Support bar and a large plug on the side of the crossover bar that does not have a handle.

Figure 70



Figure 71



Figure 72

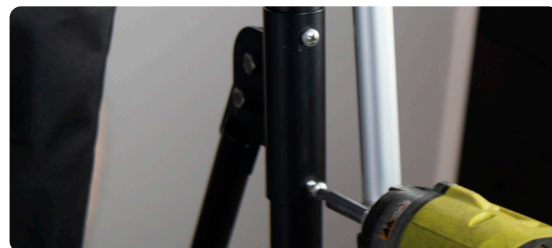

Figure 73



Figure 74



Figure 75



Figure 76



STEP 24 - FOR CONVERTALIFT SYSTEMS WITH REMOTE CONTROLS

- 24.1** Check to see if your Remote has a live battery by pushing Up button to see if the light turns on. The Remote uses standard CR2032 batteries.
- 24.2** Program the Remote by pressing and holding the red button connected to the Control Box and the “UP” button on your Remote simultaneously for approximately 3 seconds. As a back-up program the second remote. See Fig 77
- 24.3** Test both Remotes by pressing the Up button twice about a half second a part.

NOTE: The remote will open your cover from up to hundred feet away providing convenience but it is not recommended to use to close a VacuSeal cover. For safety reasons it requires that you press and hold the down button. This often causes a stuttering motion along with weakening the battery. Since the cover requires that you guide it down the key switch is the recommended way of closing the cover.

- 24.4** If you are not ready to permanently power your system at this time, make certain to close any open cabinet panels.

STEP 25 - POWERING THE CONVERTALIFT SYSTEM

There are 2 ways to Power the ConvertALift, Direct to the Spa or with a Dedicated 110V Line from home.

25.1 DIRECT WIRE TO THE SPA PAC

Cut the end off of the Power Cord, strip the wires (See Fig 79), attach the Female Spade Connectors, and attach them to a 110-Volt, Non-Switched Source on the spa pac. This is the most attractive method because it eliminates having to run an electrical cord from your home. It only draws 2 amps of current, so it shouldn't interfere with the Spa Pac's permitted amperage draw.

WARNING: DIRECT WIRE TO THE SPA PAC installations Should ONLY be done by a Licensed Electrician or a Certified Spa Technician.

25.2 DEDICATED 110V FROM YOUR HOME

Run a dedicated 110 Volt line to your Power Supply from either the main electrical panel in your home or from the external sub panel for your spa. Cut and strip the lines of your Power Cord and these lines to the Dedicated 110 Volt line from your home. Attach these lines within a Weatherproof Box kept within the interior of your spa. Then splice and connect them to the 110 Volt line within a Weatherproof Junction Box. See Fig 80

WARNING: DEDICATED 110V installations Should ONLY be done by a Licensed Electrician in accordance with local codes.

STEP 26, FINAL TEST

Test again the Key Switch and the remote if you have one. If all works well, Congratulations, your installation is successful.

Enjoy your hot tub and remember to complete the warranty information card.

Figure 77



Figure 78

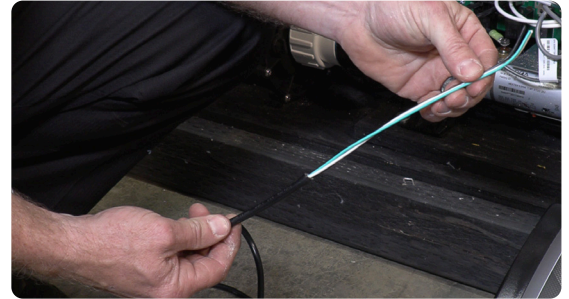

Figure 79

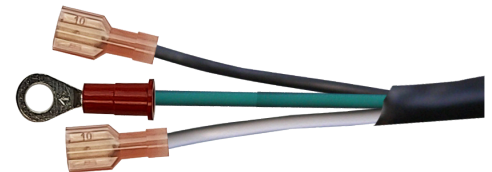
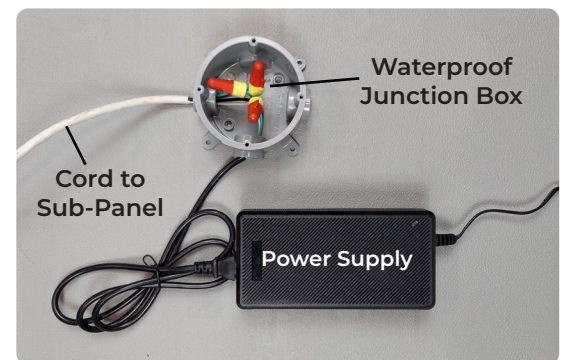

Figure 80



Keyswitch Installation Template

Attach this template to the spa as shown.

- DIRECTIONS:**
1. Cut along the dotted line.
 2. Tape Side A at the lowest part of Spa Shell against the Shell Coping.
 3. Tape Side B at the top of the Spa Cabinet against the Shell Coping

This helps you determine the horizontal position of the hole for the Key Switch.

Be certain the hole is at least 1 1/2" down from the top of Spa Cabinet then mark position of the hole with a pencil. You're now ready to drill.

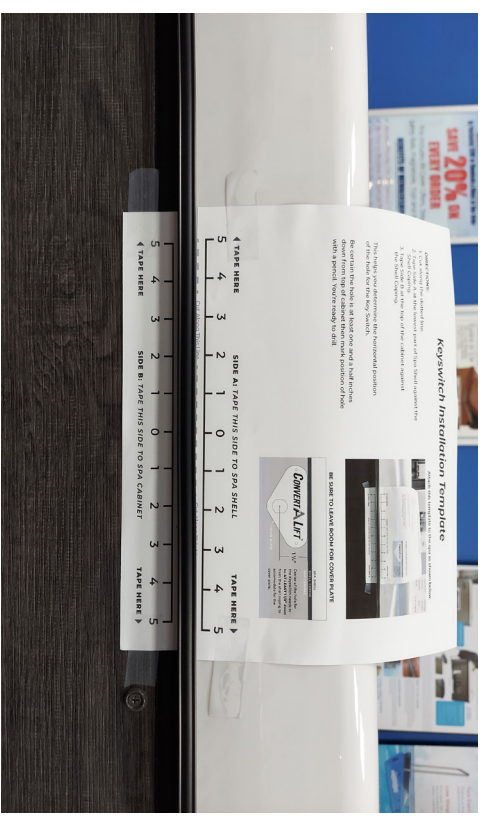

BE SURE TO LEAVE ROOM FOR COVER PLATE

